

680HE Synergy

*Hostile Environment Digital Weight Indicator
Firmware Version 1*

Technical Manual



RICE LAKE[®]
WEIGHING SYSTEMS

© Rice Lake Weighing Systems. All rights reserved.

Rice Lake Weighing Systems® is a registered trademark of
Rice Lake Weighing Systems.

All other brand or product names within this publication are trademarks or
registered trademarks of their respective companies.

All information contained within this publication is, to the best of our knowledge, complete and
accurate at the time of publication. Rice Lake Weighing Systems reserves the right to make
changes to the technology, features, specifications and design of the equipment without notice.

The most current version of this publication, software, firmware and all other product
updates can be found on our website:

www.ricelake.com

Revision History

This section tracks and describes manual revisions for awareness of major updates.

Revision	Date	Description
D	October 03, 2022	Established revision history; Updates to Audit Jumper, Audit Trail Support and Specifications; firmware version 1.04

Table i. Revision Letter History



Technical training seminars are available through Rice Lake Weighing Systems. Course descriptions and dates can be viewed at www.ricelake.com/training or obtained by calling 715-234-9171 and asking for the training department.

Contents

1.0	Introduction	1
1.1	Safety	1
1.2	FCC Compliance	2
1.3	Operating Modes	2
1.4	Option Card	2
2.0	Installation	3
2.1	Unpacking	3
2.1.1	Product Dimensions	3
2.2	Mounting Instructions	4
2.3	Interior Access	4
2.4	Cable Connections	5
2.4.1	Torque Ratings	5
2.4.2	Cable Diameter Ratings	5
2.4.3	Cable Shield Grounding	6
2.4.4	Power Cable	7
2.4.5	Load Cell Cable	7
2.4.6	RS-232 Serial Communications	7
2.4.7	RS-485/422 Serial Communications	8
2.4.8	Digital I/O	8
2.4.9	Micro USB Device Communications	9
2.4.10	Ethernet	10
2.4.11	Option Card Port	11
2.5	CPU Board	11
2.5.1	Load Cell Compensation Jumper	11
2.6	Sealing the Indicator (Optional)	12
2.7	Parts Kit Components	12
2.8	Replacement Parts	13
3.0	Operation	14
3.1	Front Panel	14
3.2	LED Annunciators	15
3.3	General Navigation	15
3.3.1	Numeric Value Entry	15
3.3.2	Alphanumeric Entry	16
3.4	General Indicator Operation	16
3.4.1	Zero Scale	16
3.4.2	Print Ticket	16
3.4.3	Toggle Units	16
3.4.4	Toggle Gross/Net Mode	16
3.4.5	Acquire Tare	17
3.4.6	Remove Stored Tare Value	17
3.4.7	Preset Tare (Keyed Tare)	17
3.4.8	Display a Stored Tare	17
3.4.9	Clear a Stored Tare	17
3.4.10	View Audit Trail Counters	18
3.4.11	View Legally Relevant Version	18
3.4.12	Display Accumulator	18



Rice Lake continually offers web-based video training on a growing selection of product-related topics at no cost. Visit www.ricelake.com/webinars

3.4.13	Print Accumulator	18
3.4.14	Clear Accumulator	19
3.4.15	Enter New Unit ID	19
3.4.16	View and Edit Time Value	19
3.4.17	View and Edit Date Value	20
3.4.18	View Configured Setpoint Values	20
3.4.19	Reset Configuration	20
4.0	Configuration	21
4.1	Setup Jumper	21
4.1.1	Audit Jumper	21
4.2	Main Menu	22
4.3	Audit Menu	22
4.4	Setup Menu	23
4.4.1	Setup – Configuration Menu	23
4.4.2	Setup – Format Menu	25
4.4.3	Setup – Calibration Menu	25
4.4.4	Setup – Communication Menu	26
4.4.5	Setup – Program Menu	30
4.4.6	Setup – Print Format Menu	33
4.4.7	Setup – Stream Format Menu	34
4.4.8	Setup – Setpoints Menu	35
4.4.9	Setup – Digital I/O Menu	38
4.4.10	Setup – Analog Output Menu	38
4.5	Accumulator Menu	39
4.6	Tare Menu	39
5.0	Calibration	40
5.1	Front Panel Calibration	40
5.1.1	Span Calibration	40
5.1.2	Linear Calibration	41
5.2	Alternative Zero Calibrations	41
5.2.1	Last Zero	41
5.2.2	Temporary Zero	41
5.2.3	Rezero	41
5.3	EDP Command Calibration	42
6.0	Revolution	43
6.1	Connecting to the Indicator	43
6.2	Saving and Transferring Data	43
6.2.1	Saving Indicator Data to a Personal Computer	43
6.2.2	Downloading Configuration Data from PC to Indicator	43
6.3	Updating Firmware	43
7.0	EDP Commands	44
7.1	Key Press Commands	44
7.2	Reporting Commands	45
7.3	Reset Configuration Command	45
7.4	Parameter Setting Commands	46
7.5	EDP Setting Commands	47
7.6	Ethernet and USB Setting Commands	48



Technical training seminars are available through Rice Lake Weighing Systems. Course descriptions and dates can be viewed at www.ricelake.com/training or obtained by calling 715-234-9171 and asking for the training department.

7.7	Stream Setting Commands	48
7.8	Program Commands	49
7.9	Regulatory Commands	49
7.10	Setpoint Commands	50
7.11	Print Format Commands	51
7.12	Digital I/O Commands	51
7.13	Analog Output Commands	51
7.14	Weigh Mode Commands	52
7.14.1	CPU Port Numbering for SX/EX commands	52
7.15	Batching Control Commands	53
8.0	Print Formatting	54
8.1	Print Formatting Tokens	54
8.2	Customizing Print Formats	56
8.2.1	Using the Front Panel	56
8.3	Non-Human Readable Characters	56
9.0	Setpoints	57
9.1	Batch and Continuous Setpoints	57
9.2	Batching Examples	59
9.2.1	Example 1	59
9.2.2	Example 2	60
10.0	Maintenance	61
10.1	Maintenance Checkpoints	61
10.2	Field Wiring	61
10.3	Troubleshooting Tips	61
10.4	Battery Replacement	62
10.5	Board Replacement	62
11.0	Appendix	63
11.1	Error Messages	63
11.1.1	Displayed Error Messages	63
11.2	ZZ EDP Command	63
11.3	Continuous Data (Stream) Output Formats	64
11.4	Custom Stream Formatting	66
11.5	Audit Trail Support	68
11.6	Conversion Factors for Secondary Units	68
11.7	Digital Filtering	68
11.7.1	Digital Rolling Average Filter (AVGONL)	68
11.7.2	Adaptive Filter (ADPONL)	69
11.7.3	Damping Filter (DMPONL)	70
11.8	Regulatory Mode Functions	70
11.9	ASCII Character Chart	71
11.10	Front Panel Display Characters	72
12.0	Compliance	73
13.0	Specifications	75



Rice Lake continually offers web-based video training on a growing selection of product-related topics at no cost. Visit www.ricelake.com/webinars

1.0 Introduction

This manual is intended for use by service technicians responsible for installing and servicing 680HE digital weight indicators. Configuration and calibration of the indicator can be accomplished using the Revolution® configuration utility or the indicator front panel keys. See [Section 4.0 on page 21](#) and [Section 5.0 on page 40](#) for information about configuration and calibration.



Manuals and additional resources are available from the Rice Lake Weighing Systems website at www.ricelake.com
Warranty information can be found on the website at www.ricelake.com/warranties

1.1 Safety

Safety Definitions:



DANGER: Indicates an imminently hazardous situation that, if not avoided, will result in death or serious injury. Includes hazards that are exposed when guards are removed.



WARNING: Indicates a potentially hazardous situation that, if not avoided, could result in serious injury or death. Includes hazards that are exposed when guards are removed.



CAUTION: Indicates a potentially hazardous situation that, if not avoided, could result in minor or moderate injury.



IMPORTANT: Indicates information about procedures that, if not observed, could result in damage to equipment or corruption to and loss of data.

General Safety



Do not operate or work on this equipment unless this manual has been read and all instructions are understood. Failure to follow the instructions or heed the warnings could result in injury or death. Contact any Rice Lake Weighing Systems dealer for replacement manuals.



WARNING

Failure to heed could result in serious injury or death.

Some procedures described in this manual require work inside the indicator enclosure. These procedures are to be performed by qualified service personnel only.

Ensure the power cord is disconnected from the outlet before opening the unit.

Do not allow minors (children) or inexperienced persons to operate this unit.

Do not operate without the enclosure completely assembled.

Do not use for purposes other than weight taking.

Do not place fingers into slots or possible pinch points.

Do not use this product if any of the components are cracked.

Do not exceed the rated specification of the unit.

Only connect unit to equipment certified to IEC 60950, IEC 62368, IEC 61010 or similar.

Do not make alterations or modifications to the unit.

Do not remove or obscure warning labels.

Do not use solvents or aggressive substances to clean the indicator.

Do not submerge.

1.2 FCC Compliance

United States

This equipment has been tested and found to comply with the limits for a Class A digital device, pursuant to Part 15 of the FCC Rules. These limits are designed to provide reasonable protection against harmful interference when the equipment is operated in a commercial environment. This equipment generates, uses, and can radiate radio frequency energy and, if not installed and used in accordance with the instruction manual, may cause harmful interference to radio communications. Operation of this equipment in a residential area is likely to cause harmful interference in which case the user will be required to correct the interference at his own expense.

Canada

This digital apparatus does not exceed the Class A limits for radio noise emissions from digital apparatus set out in the Radio Interference Regulations of the Canadian Department of Communications.

Le présent appareil numérique n'émet pas de bruits radioélectriques dépassant les limites applicables aux appareils numériques de la Class A prescrites dans le Règlement sur le brouillage radioélectrique édicté par le ministère des Communications du Canada.

1.3 Operating Modes

Weigh Mode

Weigh mode is the default mode of the indicator. The indicator displays gross or net weights as required, using the annunciators to indicate scale status and the type of weight value displayed.

User Mode

User mode is accessible by pressing  on the front panel. The indicator displays the audit, accumulator, tare and version menus when in user mode.

Setup Mode

Most of the procedures described in this manual, including calibration, require the indicator to be in setup mode.

See [Section 4.0 on page 21](#) for the procedure to enter setup mode and the parameters available.

1.4 Option Card

The 680HE has a single option card slot which can support the Synergy Series Single Analog Output Option Card (PN 195084). The Synergy Series Single Analog Output Option Card kit includes instructions for installation and setup.

2.0 Installation

This section describes procedures for connecting power, load cells, digital I/O and data communication cables to a 680HE indicator. An assembly drawing and parts list are included for the service technician.



WARNING



Risk of electrical shock.

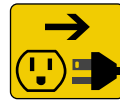

Disconnect power before servicing.



AVERTISSEMENT

Risque de choc.

Débranchez l'alimentation avant l'entretien.



CAUTION: Risk of explosion if battery is replaced by an incorrect type. Dispose of used batteries according to state and local regulations.



ATTENTION: Risque d'explosion si la batterie est remplacée par un type incorrect. Mettre au rebut les batteries usagées selon les règlements d'état et locaux.

Use anti-static protection for grounding and to protect components from electrostatic discharge (ESD) when working inside the 680HE enclosure.

Procedures requiring work inside the 680HE must be performed by qualified service personnel only.

The socket/outlet must be near the equipment and must be easily accessible.

2.1 Unpacking

Immediately after unpacking, visually inspect the 680HE to ensure all components are included and undamaged. The shipping carton contains the indicator, this manual and a parts kit (Section 2.7 on page 12). If parts were damaged in shipment, notify Rice Lake Weighing Systems and the shipper immediately.

2.1.1 Product Dimensions

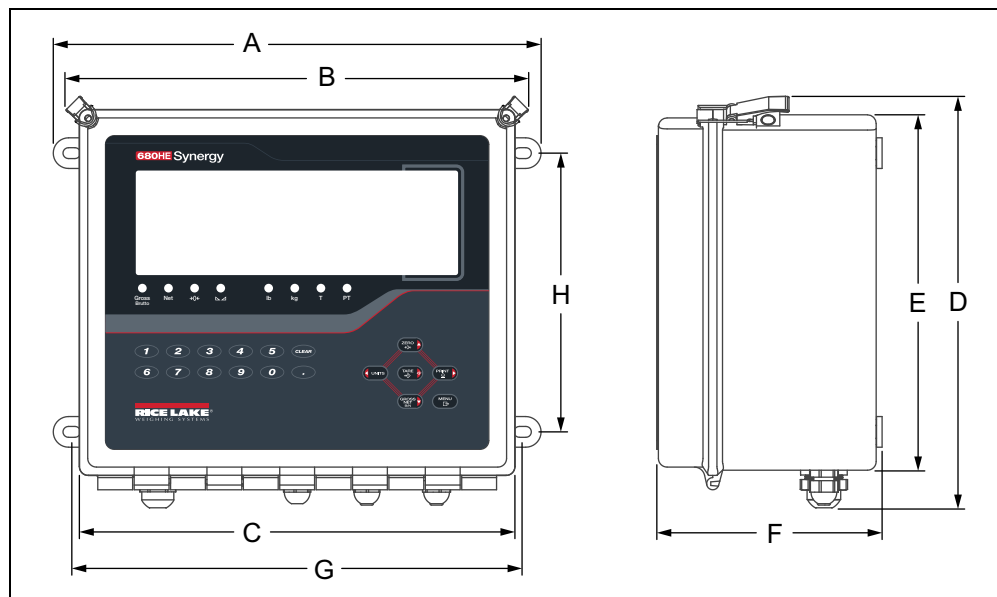

Figure 2-1. Product Diagram

A	B	C	D	E	F	G	H
14.0" (355.6 mm)	13.3" (337.8 mm)	12.5" (317.5 mm)	11.8" (299.7 mm)	10.5" (266.7 mm)	6.5" (165.1 mm)	13.0" (330.2 mm)	8.0" (203.2 mm)

Table 2-1. Product Dimensions

2.2 Mounting Instructions

The 680HE can be mounted on a wall or vertical surface using the mounting feet on the sides of the enclosure.

1. Using the mounting feet holes as a template, mark the screw locations.
2. Drill holes for the screws.
3. Secure the 680HE enclosure using the appropriate length 1/4" or M6 hardware (not included).

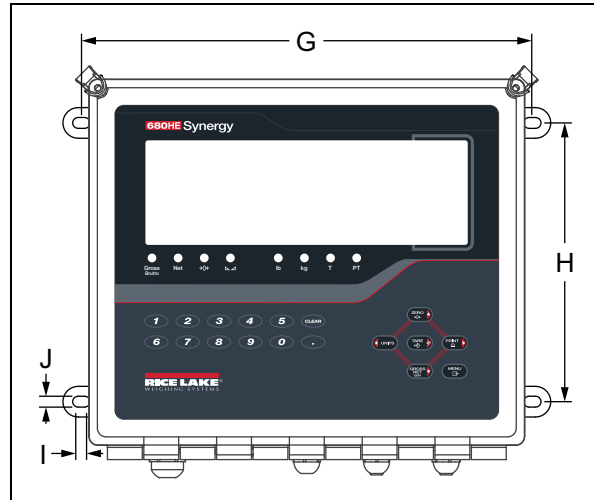

Figure 2-2. Product Mounting Diagram

G	H	I	J
13.0" (330.2 mm)	8.0" (203.2 mm)	0.49" (330.2 mm)	0.31" (203.2 mm)

Table 2-2. Product Mounting Dimensions

2.3 Interior Access

Open the enclosure of the 680HE to gain access and connect cables to the 680HE boards and power supply.



WARNING: Before opening the unit, ensure the power cord is disconnected from the power outlet.



IMPORTANT: Use anti-static protection for grounding and to protect components from electrostatic discharge (ESD) when working inside the 680HE enclosure.

1. Release the two latches at the top of the enclosure securing the front door.
2. Carefully swing open the front door of the enclosure.



Figure 2-3. Front Door Latches



NOTE: Breaking a seal that restricts access to the interior of the 680HE terminates the Legal for Trade status.

2.4 Cable Connections

The 680HE provides four cord grips at the bottom of the enclosure for cabling into the indicator. One of the cord grips is used for the power supply and the other three are used to accommodate the load cell cable and the serial, digital inputs and outputs, Ethernet or the optional analog output communications cables. An RJ45 connector can also be added as an available option. Cable plugs are included in the parts kit and must be installed in open cord grips to prevent moisture from entering the enclosure. The optional RJ45 connector comes with a cap to seal the connector when not in use. See the following sections to install cables as required for the application. The recommended cable strip length is 0.25" (7 mm) for all 680HE connectors. See [Figure 2-4](#) for the recommended assignments for the 680HE cord grips.



WARNING: Only connect unit to equipment certified to IEC 60950, IEC 62368, IEC 61010 or similar.

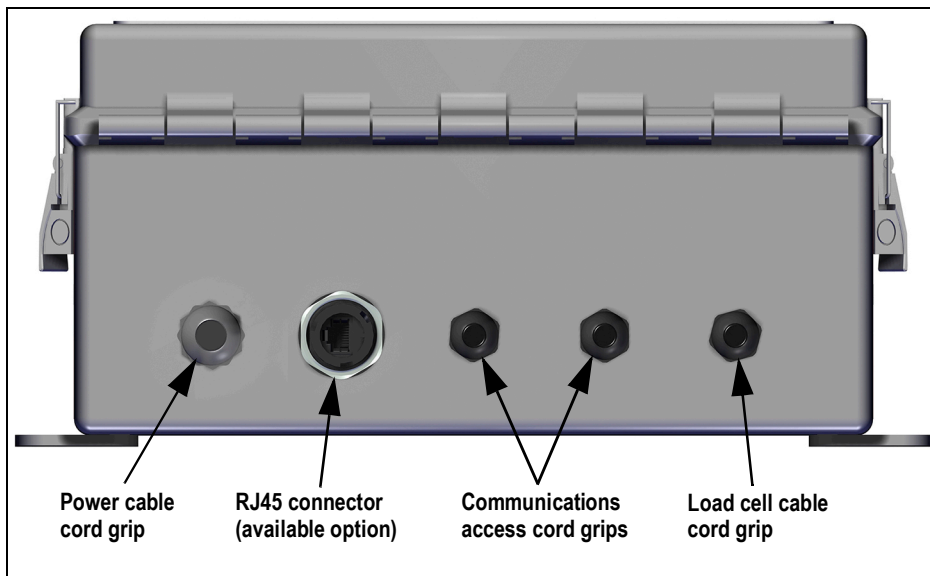

Figure 2-4. Recommended Cord Grip Assignments



IMPORTANT: Do not have open/bare wires outside of the enclosure. Make sure no stripped portion of cable is on the outside of the cord grips.



NOTE: The recommended cable strip length is 0.25" (7 mm) for all 680HE connectors.

2.4.1 Torque Ratings

Refer to [Table 2-3](#) throughout installation and the use of the product to maintain proper torque ratings for 680HE components.

Component	Torque Rating
Power Supply Screw	4 in-lb (0.5 N-m)
Ground Fastener Screw	12 in-lb (1.4 N-m)
Cord Grip Nut (to enclosure)	33 in-lb (3.7 N-m)
Cord Grip Dome Nut (around cable)	22 in-lb (2.5 N-m)
RJ45 Bulkhead (option)	20 in-lb (2.3 N-m)

Table 2-3. Component Torque Ratings



NOTE: For reference, it is recommended to tighten the cord grip dome nuts until the rubber insert starts to bulge.

2.4.2 Cable Diameter Ratings

Refer to [Table 2-4](#) for minimum and maximum cable sizes for use with the cord grips.

Cord Grip	Diameter Range
3/8 NPT (PN 15655)	0.138 - 0.315 in (3.5 - 8 mm)
PG-11 (PN 68600)	0.197 - 0.394 in (5 - 10 mm)

Table 2-4. Cord Grip Cable Diameter Ratings

2.4.3 Cable Shield Grounding

Except for the power cord, all cables routed through the cord grips must be shield grounded.

- Use hardware provided in the parts kit to install shielding clamps on the back panel of the enclosure
- Install only the necessary amount of shielding clamps for the cord grips to be used
- Remove the insulated jackets and shielding per the following instructions

Shielding Procedure

1. Install the shielding clamps to the threaded grounding holes on the back panel of the enclosure using the clamp screws provided in the parts kit. Finger tighten the screws at this time.
2. Route the cables through the cord grips and the shielding clamps to determine the cable lengths required to reach the appropriate cable connectors.
3. Mark cables to remove the insulated jacket as described below for Foil Shielded Cables and Braid Shielded Cables.

Foil Shielded Cables

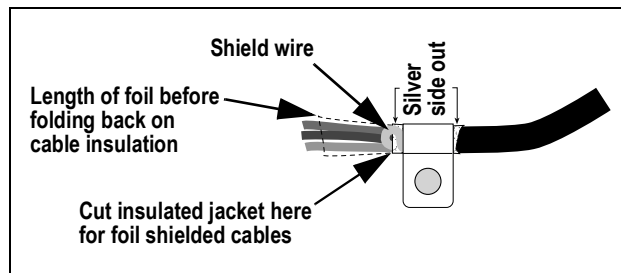

Figure 2-5. Foil Shielded Cable

1. Strip the insulated jacket and foil 1/2" (15 mm) past the shielding clamp.
2. Strip another 1/2" of the insulated jacket, leaving the foil shielding exposed.
3. Fold the foil shielding back on the cable where the cable passes through the clamp.
4. Ensure the silver (conductive) side of the foil is turned outward.
5. Wrap the shield wire around the cable, ensuring it contacts the foil where the cable passes through the clamp.
6. Torque shielding clamp screw to 10 in-lb (1.1 N-m), ensuring clamp is around the cable and contacting the shield wire.

Braid Shielded Cables

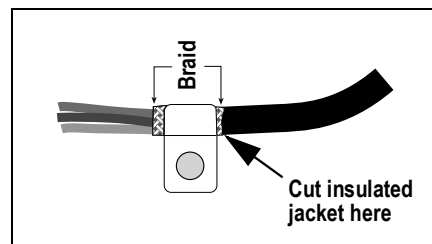

Figure 2-6. Braid Shielded Cable

1. Strip the insulated jacket and braided shielding from a point just past the shielding clamp.
2. Strip another 1/2" (15 mm) of the insulated jacket, leaving the braid exposed where the cable passes through the clamp.
3. Torque shielding clamp screw to 10 in-lb (1.1 N-m), ensuring the clamp is contacting the braided shielding of cable.

2.4.4 Power Cable

AC versions of the 680HE are shipped with the AC power cable already installed.



NOTE: The AC power cable is grounded to the threaded grounding hole on the back panel of the enclosure between the cord grip and the power supply connections rather than using Pin 3. This is a UL requirement.

Pin	Description	Wire Color	Cable Part No.
1	120 VAC (Line In)	Brown	180842
2	AC Neutral	Blue	
3	Ground	N/C	–
4	DC Out (-V)	Black	199514
5	DC Out (+V)	Red	

Table 2-5. AC Power Supply Pin Assignments

2.4.5 Load Cell Cable

To attach the cable from a load cell or junction box, route cable to the J1 connector ([Section 2.5 on page 11](#)). Connector for the cable is included in the parts kit. See [Table 2-6](#) for wiring the load cell cable from the load cell or junction box to connector.



A ferrite from the parts kit must be applied to the load cell cable within 1" (25 mm) of the load cell. The cable must be sent through the ferrite twice.

Connector	Pin	Function
J1	1	+SIG
	2	-SIG
	3	+SENSE
	4	-SENSE
	5	+EXC
	6	-EXC

Table 2-6. J1 Pin Assignments (Load Cell)



NOTE: For a 4-wire installation leave pins 3 and 4 empty on the connector.

NOTE: For a 6-wire installation set the SENSE parameter to 6-WIRE in the CONFIG menu ([Section 4.4.1 on page 23](#)).

2.4.6 RS-232 Serial Communications

The J3 connector ([Section 2.5 on page 11](#)) is intended to provide a connection point for the RS-232 serial communications. Two RS-232 ports are available. See [Table 2-7](#) for the pin assignments for the J3 connector.

Connector	Pin	RS-232 Port 1	RS-232 Port 2
J3	1	GND	–
	2	RX1	–
	3	TX1	–
	4	–	GND
	5	–	RX2
	6	–	TX2

Table 2-7. J3 Pin Assignments (RS-232)



NOTE: RS-232 Port 1 = RS2321 and RS-232 Port 2 = RS2322 in the 680HE menu structure.

2.4.7 RS-485/422 Serial Communications

The J4 connector ([Section 2.5 on page 11](#)) is intended to provide a connection point for the RS-485/422 serial communications. Both full duplex (four-wire) and half duplex (two-wire) are supported through the J4 connector. See [Table 2-8](#) for the pin assignments for the J4 connector.

Connector	Pin	4-Wire (Full Duplex)	2-Wire (Half Duplex)
J4	1	GND	GND
	2	A	–
	3	B	–
	4	Y	Y
	5	Z	Z

Table 2-8. J4 Pin Assignments (RS-485/422)

2.4.8 Digital I/O

The Digital I/O port, J5 connector ([Section 2.5 on page 11](#)) is intended to be connected to both digital inputs and outputs.

Digital inputs can be set to provide many functions, including most keypad functions except MENU. Digital inputs are active low (0 VDC) and inactive high (5 VDC). Use the Digital I/O menu to configure the digital inputs.

Digital outputs are used to control relays which drive other equipment. Outputs are designed to sink, rather than source current. Each output is an open collector circuit, capable of sinking 20 mA when active. Digital outputs are active when low or at 0 VDC, with reference to the 5 VDC supply.

Use the Digital I/O menu to set the function of the Digital I/O pins to OUTPUT and then use the Setpoints menu to configure the digital outputs. See [Table 2-9](#) for the pin assignments for the J5 connector.

Connector	Pin	Signal
J5	1	5 VDC, 250 mA max
	2	GND
	3	DIO1
	4	DIO2
	5	DIO3
	6	DIO4

Table 2-9. J5 Pin Assignments (Digital I/O)

2.4.9 Micro USB Device Communications

The Micro USB port, J7 connector ([Section 2.5 on page 11](#)), is intended to be connected to a PC only and should only be used as a service port. It appears as a Virtual COM Port and is assigned a “COMx” designation. Applications communicate through the port like a standard RS-232 communications port.

The driver must be installed on the PC before the device port can be used. With the PC and 680HE powered on, connect a USB cable from the PC to the micro USB connector (J7) on the 680HE. The PC recognizes if a device has been connected, and attempts to install the driver needed to make it work. The driver can also be downloaded from the [Rice Lake website](#).



NOTE: *If using Windows 7 or later and the PC is connected to the Internet, the operating system may be able to install the drivers automatically.*

When the individual drivers are installed, a new COM Port designation is assigned for each physical USB port the 680HE is connected to on the PC.

For example, if the PC has two physical RS-232 COM Ports, they most likely are designated COM1 and COM2. When connecting the 680HE to a USB port on the PC, it is assigned the next available port designation, or in this case, COM3. When plugging into the same physical USB port on the PC, the port designation is again COM3. If plugging into another physical USB port on the PC, it is assigned the next available designation, in this case COM4.

After the drivers are installed, use Windows® Device Manager to determine the COM Port designation which was assigned to the USB port, or open the application to be used with the 680HE, such as Revolution, to see which ports are available.

Configuration of the Micro USB port is done in the USBCOM sub-menu under PORTS in setup mode.

The port can be configured as either a demand port for EDP commands and printing, or as a data streaming port. Other settings include the termination character(s), echoes, responses, the end-of-line delay and whether or not the 680HE displays a 'print' message when a print format sends data out the port.



NOTE: *If a computer application has an open communications connection through the Micro USB device port and the physical cable connection is interrupted, a soft reset must be performed on the 680HE or the power must be cycled to the 680HE; the connection in the computer application must be disconnected and then reconnected before it continues to communicate with the 680HE.*

NOTE: *For the Micro USB device port, it does not matter what the settings are for Baud, Data Bits, Parity and Stop Bits in the computer software. The port communicates in the same way regardless of these settings.*

NOTE: *This port is not a host port and is not intended to be connected to other devices such as keyboards, memory sticks or printers.*

2.4.10 Ethernet

The 680HE features Ethernet TCP/IP 10Base-T/100Base-TX communication using the J8 connector ([Section 2.5 on page 11](#)), and can support two simultaneous connections, one as a server, the other as a client.

Through an Ethernet network, software applications can communicate with the 680HE using the EDP command set ([Section 7.0 on page 44](#)), or data can be streamed continuously from the 680HE, or printed on demand.

The Ethernet port supports both DHCP and manual configuration of settings such as the IP and netmask. In addition, the TCP Port number, and the Default Gateway can be configured using the Ethernet sub-menu of the Ports setup menu. For more information on configuring the Ethernet port see [Section 4.4.4.3 on page 29](#).

Physical connection to the 680HE Ethernet port can be made directly from a PC to the 680HE (AdHoc Network), or through a network router or switch. The port supports auto-sensing MDI/MDIX cable configuration, allowing either straight-through or crossover cables to be used. See [Table 2-10](#) for the pin assignments for the J8 connector.

Connector	Pin	Signal
J8	1	TX+
	2	TX-
	3	RX+
	4	RX-

Table 2-10. J8 Pin Assignments (Ethernet)



NOTE: When looking into the enclosure from the backside of the indicator, pin 1 of the J8 connector is at the bottom.

See [Table 2-11](#) and [Table 2-12](#) for the pin assignments when connecting a RJ45 Ethernet cable to the J8 connector. There are two Ethernet wire standards (T568A and T568B). If the type of cable is unknown, use the wiring option in [Table 2-11](#). The auto-sensing feature of the Ethernet port allows either of the wiring options to work. Trim the unused wires to get them out of the way.

RJ45 Cable Pin No.	Wire Color (T568A)	Wire Diagram (T568A)	10Base-T Signal 100Base-TX Signal	J8 Connector Pin No.
1	White/Green		Transmit+	1
2	Green		Transmit-	2
3	White/Orange		Receive+	3
4	Blue		Unused	NA
5	White/Blue		Unused	NA
6	Orange		Receive-	4
7	White/Brown		Unused	NA
8	Brown		Unused	NA

Table 2-11. Ethernet Cable Pin Assignments for T568A

RJ45 Cable Pin No.	Wire Color (T568B)	Wire Diagram (T568B)	10Base-T Signal 100Base-TX Signal	J8 Connector Pin No.
1	White/Orange		Transmit+	1
2	Orange		Transmit-	2
3	White/Green		Receive+	3
4	Blue		Unused	NA
5	White/Blue		Unused	NA
6	Green		Receive-	4
7	White/Brown		Unused	NA
8	Brown		Unused	NA

Table 2-12. Ethernet Cable Pin Assignments for T568B

2.4.11 Option Card Port

The 680HE has a single option card slot which uses the J22 and J23 connectors (Section 2.5). Instructions to install, setup or replace an option card are provided with the option card.

2.5 CPU Board

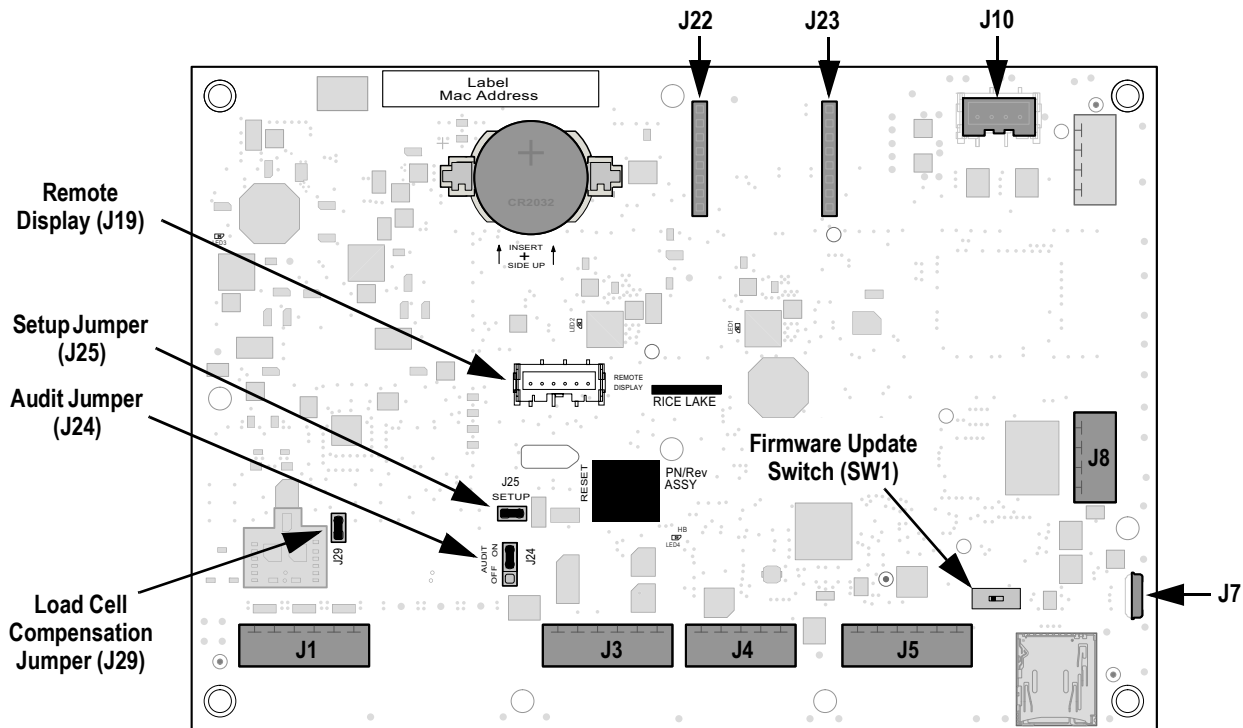

Figure 2-7. 680HE CPU Board

Connectors

- Load Cell (J1)
- RS-485/422 (J4)
- Micro USB (J7)
- Power (J10)
- RS-232 1-2 (J3)
- Digital I/O (J5)
- Ethernet (J8)
- Option Slot (J22/J23)

2.5.1 Load Cell Compensation Jumper

The load cell compensation jumper, J29 (Figure 2-7), must be set ON for load cells with balanced bridges and set to OFF for load cells with unbalanced bridges. When OFF, the compensation jumper has the effect of lowering the excitation voltage. Uncompensated unbalanced load cells can cause instability or calibration errors.

Use the following procedure to determine the correct jumper position if the load cell type is unknown.

1. Disconnect load cell from indicator and use an ohmmeter to measure the following:
 - +EXC to +SIG, +EXC to -SIG
 - -EXC to +SIG, -EXC to -SIG



NOTE: Measured values between the excitation line and each of the signal lines should be within 2–3 Ω .

2. If the +EXC measurements are $\geq 5\%$ larger than the -EXC measurements, set the compensation jumper in the OFF position to compensate for the unbalanced load cell.

If the +EXC measurements are $< 5\%$ greater (or are less) than the -EXC measurements, set the jumper in the ON position for the balanced load cell.

2.6 Sealing the Indicator (Optional)

Use a lead wire seal to restrict access of the setup and audit jumpers, electronics, electrical contacts and Legal for Trade configuration parameters of the 680HE.



NOTE: The audit jumper (J24) must be set to OFF to restrict access to the configuration parameters.



Figure 2-8. Sealing the Indicator – No Access

1. Insert the two provided clevis pins (PN 200864) through the front door latches of the 680HE, as shown in [Figure 2-8](#).
2. Navigate the sealing wire through each hole at the ends of the two clevis pins.
3. Seal the wire to secure.



NOTE: Two sealing wires are used in [Figure 2-8](#) due to the length of the sealing wires.

2.7 Parts Kit Components

Part No.	Description	Qty
15631	Cable Tie, 3" Nylon	4
15650	Mount, Cable Tie 3/4"	2
194446	Ferrite Core, Snap on Fair-rite	1
19538	Post Plug, Slotted Black Plastic Stem, 1/4 x 1, Seals Inside Cord Grip	3
195993	Connector, 6 Position Screw Terminal Pluggable 3.50 mm Black	3
195995	Connector, 4 Position Screw Terminal Pluggable 3.50 mm Black	1
195998	Connector, 5 Position Screw Terminal Pluggable 3.50 mm Black	1
200864	Clevis Pin, 5/16 x 1 inch 316 SST	2
53075	Clamp, Ground Cable Shield, Radius 0.078"	4
67550	Clamp, Ground Cable Shield, Radius 0.125	2
202140	Screw, Mach M4 x 0.7 x 10 Phillips Pan Head with External Tooth Washer SEMS	6
94422	Label, Capacity 0.40 x 5.00	1

Table 2-13. Parts Kit (PN 200034) Components

2.8 Replacement Parts

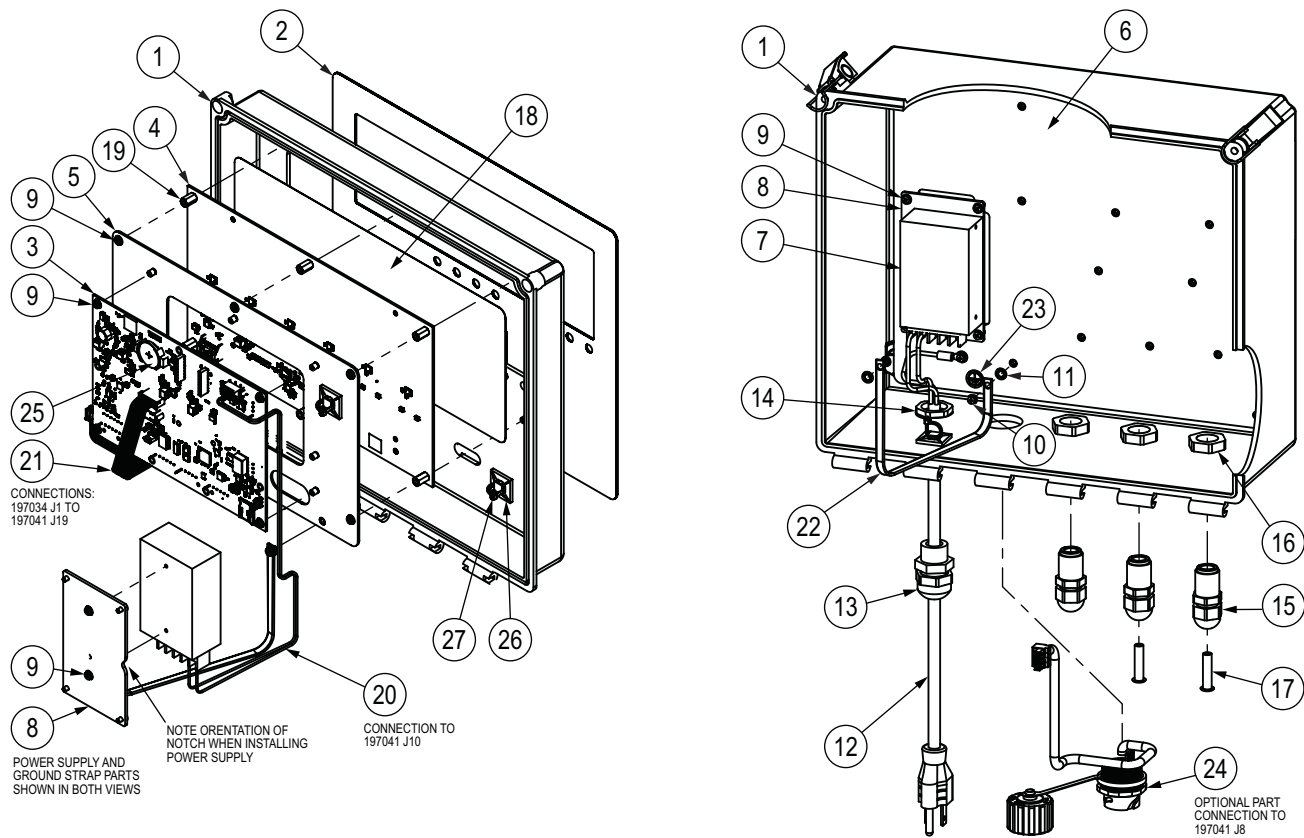

Figure 2-9. Replacement Parts Diagram

Item	Part No.	Description	Qty
1	196705	Enclosure, Machined FRP	1
	199370	Enclosure, Machined FRP with RJ45 Option	1
2	197174	Overlay, 680HE Indicator Membrane Switch with Numeric Keys	1
3	197041	CPU Board Assembly, ROHS	1
4	197034	Display Board Assembly, ROHS	1
5	197981	Front Panel Assembly, CPU Mount	1
6	197982	Back Panel Assembly, Power Supply Mount	1
7	92463	Power Supply, Switching 90-264 VAC Input, 12 VDC Output 2.1A, 25W	1
8	199008	Plate, 680HE Power Supply	1
9	194487	Screw, Machine M3-0.5 x 6 Phillips Pan Head Steel External Tooth Washer SEMS	21
10	194488	Screw, Machine M4-0.7 x 6 Phillips Pan Head Steel External Tooth Washer SEMS	3
11	180856	Washer, M4 Internal Tooth SST	3
12	180842	AC Power Cord Assembly, NEMA 5-15	1
13	68600	Cord Grip, PG11	1
14	68601	Nut, PG11 Black Nylon	1

Item	Part No.	Description	Qty
15	15655	Cord Grip, 3/8 NPT	3
16	15656	Locknut, 3/8 NPT	3
17	19538	Cord Grip Post, Slotted Black Seal 1/4 x 1	2
18	199410	Shield, ESD Lens for 680HE	1
19	130470	Male-FEM Standoff, M3-0.5 x 10mm Nickel Plated Brass	6
20	199514	Cable Assembly, Power Harness, 2 Position, Flying Lead	1
21	197697	Cable Assembly, Display Harness, 6 Position	1
22	199573	Ground Strap, 304mm Jacketed Tinned Braid M4 Ring Terminals	1
23	16892	Label, Ground Protective Earth Adhesive IEC 60417-5019	1
24	200296	RJ45 Cable Assembly Option, RJ45 Bulkhead to Four Position 3.50mm Spacing Connector	1
25	71408	Battery, CR2032 3V Lithium Manganese Dioxide	1
26	15650	Mount, Cable Tie 3/4 inch	3
27	15631	Cable Tie, 3 inch Nylon	3
-	200034	680HE Indicator Parts Kit	1

Table 2-14. Replacement Parts List

3.0 Operation

The front panel consists of a seven-segment display with six 2.5" (63.5 mm) tall digits. Front panel also includes 18 flat membrane panel, tactile feel buttons, which include six primary scale function buttons and a numeric keypad. There are eight LED annunciators for units and scale functions.

3.1 Front Panel



Figure 3-1. 680HE Front Panel



NOTE: See [Section 4.4.5 on page 30](#) for display digit brightness and color options.

Key	Function
	The Menu key is used to access user mode; See Section 4.1 on page 21 for more information on setting up the Menu key to access setup mode parameters
	Sets the current gross weight to zero, provided the amount of weight to be removed or added is within the specified zero range and the scale is not in motion; The zero band is defaulted to 1.9% of full scale, but can be configured for up to 100% of full scale; Also used as the up key to navigate menus
	Switches the weight display to an alternate unit; The alternate unit is defined in the Configuration menu, and could be kg, g, lb, oz, tn or t; Also used as the left key to navigate menus or to toggle to another digit when editing a value
	Sends on-demand print format out the configured port, provided the conditions for standstill are met; RS-232 Port 1 (RS2321) is the default print port; Also used as the right key to navigate menus or to toggle to another digit when editing a value
	Performs one of several predetermined Tare functions dependent on the mode of operation selected in the TAREFN parameter; Also acts as an enter key for numeric or parameter entry
	Switches the display mode from gross to net, or from net to gross; If a tare value has been entered or acquired, the net value is the gross weight minus the tare; Gross mode is represented by the Gross/Brutto annunciator; net mode is represented by the Net annunciator; Also used as the down key to navigate menus
	Clears current value in a numeric entry or clears the currently selected digit in an alphanumeric entry

Table 3-1. Buttons and Descriptions

3.2 LED Annunciators

The 680HE display uses a set of eight LED annunciators to provide additional information about the value being displayed.

LED	Description
Gross Brutto	Gross/Brutto LED – Gross weight display mode (or Brutto in OIML mode)
Net	Net LED – Net weight display mode
→0←	The Center of Zero LED – Indicates the current gross weight reading is within ± 0.25 display divisions of the acquired zero, or is within the center of zero band; A display division is the resolution of the displayed weight value, or the smallest incremental increase or decrease which can be displayed or printed
▢▢	Standstill LED – Scale is at standstill or within the specified motion band; Some operations, including zero, tare and print, can only be done when the standstill LED is on
lb	lb and kg LEDs:
kg	Displays which unit of measure is being used; lb and kg annunciators indicate the units associated with the displayed value; The displayed units can also be set to short tons (tn), metric tons (t), ounces (oz), grams (g) or none (no units information displayed); The lb and kg LEDs function as primary and secondary units annunciators; If neither primary nor secondary units are lb or kg, the lb annunciator is lit for primary units and kg is lit for secondary units
T	Tare LED – Indicates a push-button tare weight has been acquired and stored in memory
PT	Preset Tare LED – Indicates a preset tare weight has been keyed in or entered and stored in memory

Table 3-2. LED Annunciators

3.3 General Navigation

The front panel scale function buttons are also used to navigate through the menu structure.

- **UNITS** and **PRINT** move left and right (horizontally) in a menu level
- **ZERO** and **GROSS NET B/N** move up and down to different menu levels
- **TARE** enters a menu or parameter and selects/saves parameter settings or values
- **MENU** to access user mode, to leave a parameter without making changes, or to return to weigh mode
- Use the numeric keypad to enter a value and press **TARE** to accept the value ([Section 3.3.1](#))

3.3.1 Numeric Value Entry

Several parameters in the menu structure require the entry of a numeric value rather than the making of a selection.

Follow this procedure to enter a numeric value:

1. Press **GROSS NET B/N** or **TARE** to enter into a parameter. The current parameter value displays.
2. Press **CLEAR** to clear the current value.
3. Use the numeric keypad to enter a new value.
4. If necessary, press **GROSS NET B/N** to make the value negative.
5. Press **TARE** to save the new value. The next parameter in the menu displays.

 **NOTE:** Pressing **ZERO** also saves the new value, but the indicator returns up to the current parameter, rather than to the next parameter in the menu.

3.3.2 Alphanumeric Entry

Several parameters in the menu structure require the entry of an alphanumeric value rather than the making of a selection.



NOTE: The end of the alphanumeric character string is indicated by the “_.” character symbol.

Follow this procedure to enter an alphanumeric value:

1. Press or to enter into the parameter. The current parameter entry displays.
2. Press or to move to the character to be edited.
3. Press to enter into the character options for the location at the far right of the display.
4. Press or to scroll through available character or use the numeric keypad to enter in the ASCII value of the intended character (Section 11.9 on page 71).
5. Press to select the currently displayed character. The selected character displays in the second display field.
6. Press to enter into the character options again for the next character.
7. Press again or press to clear the current character.
8. Repeat the previous steps until alphanumeric entry is complete.
9. Press to save the new entry.



NOTE: Press to leave the parameter without saving the changes.

3.4 General Indicator Operation

This section summarizes basic 680HE operations.

3.4.1 Zero Scale

1. In gross mode, remove all weight from the scale and wait for the LED to light.
2. Press . The LED lights to indicate the scale is zeroed.



NOTE: The scale must be stable and within the configured zero range for the scale to be zeroed. If the scale cannot be zeroed, see Section 11.1.1 on page 63.

3.4.2 Print Ticket

1. Wait for the LED to be lit.
2. Press to send data to the configured port. RS-232 Port 1 is the default print port (Section 2.4.6 on page 7).

If the LED is not lit and is pressed, the print action only occurs if the scale comes out of motion within three seconds. If the scale stays in motion for over three seconds, the press is ignored.

3.4.3 Toggle Units



Press to toggle between primary and secondary units. The current unit LED is lit.

3.4.4 Toggle Gross/Net Mode





Net mode is available when a tare value has been entered or acquired (Net = Gross minus Tare). If tare has not been entered or acquired, the display remains in gross mode. The LED above Gross or Net indicate the current mode.

Press to toggle the display mode between gross and net.

3.4.5 Acquire Tare



1. Place a container on the scale and wait for the  LED to light.
2. Press  to acquire the tare weight of the container. The net weight displays and the Net LED and T LED light, confirming the tare value was entered.

3.4.6 Remove Stored Tare Value

1. Remove all weight from the scale and wait for the  LED to light. The display reads the negative tare value and the  LED is lit.
2. Press  to zero the scale, if needed.
3. Press  (or  in OIML mode). Display changes to gross weight and the Gross LED lights.

3.4.7 Preset Tare (Keyed Tare)









Tare mode must be set to keyed or both for the preset tare feature to function.

1. Remove all weight from the scale and wait for the  LED and  LED to light.
2. With the scale displaying zero weight, use the numeric keypad to enter the tare weight value and press .
3. The display changes to net weight and the Net LED and PT LED light, confirming the preset tare was entered.

















NOTE: Press  again while the  and  LED is lit, or enter a keyed tare of zero to remove the preset tare value

3.4.8 Display a Stored Tare

1. Press .  displays.
2. Press  or  until  displays.
3. Press .  displays.
4. Press . The stored tare value displays.
5. Press  twice to return to weigh mode.









If there is not a tare in the system, the value displayed is zero.

3.4.9 Clear a Stored Tare







1. Press .  displays.
2. Press  or  until  displays.
3. Press .  displays.
4. Press .  displays.
5. Press  or  to clear the stored tare value.  displays.
6. Press  or  to return the audit menu.
7. Press  to return to weigh mode.

3.4.10 View Audit Trail Counters









The audit trail calibration and configuration counters can be viewed in user mode.

1. Press . *AUDIT* displays.
2. Press . *LRW* displays.
3. Press . *CALIBR* displays.
4. Press . The audit trail calibration counter displays.
5. Press . *CALIBR* displays.
6. Press . *CONFIG* displays.
7. Press . The audit trail configuration counter displays.
8. Press  twice to return to weigh mode.











3.4.11 View Legally Relevant Version

1. Press . *AUDIT* displays.
2. Press . *LRW* displays.
3. Press . The legally relevant version displays.
4. Press  or  to return the audit menu parameters.
5. Press  twice to return to weigh mode.











3.4.12 Display Accumulator

1. Press . *AUDIT* displays.
2. Press  or  until *ACCUM* displays.
3. Press . *DISPACC* displays.
4. Press . The accumulator value displays.
5. Press  or  to return the accumulator menu parameters.
6. Press  to return to weigh mode.

3.4.13 Print Accumulator









1. Press . *AUDIT* displays.
2. Press  or  until *ACCUM* displays.
3. Press . *DISPACC* displays.
4. Press . *PRTACC* displays.
5. Press  or  to print the accumulator value. *OFF* displays.
6. Press  or  to return the accumulator menu parameters.
7. Press  to return to weigh mode.

3.4.14 Clear Accumulator

1. Press . $\text{RUD}_1 \text{E}$ displays.
2. Press  or  until RECU displays.
3. Press . dSPAC displays.
4. Press . CLRAC displays.
5. Press  or  to clear the accumulator value. OF displays.
6. Press  or  to return the accumulator menu parameters.
7. Press  to return to weigh mode.







3.4.15 Enter New Unit ID

Entering a new Unit ID requires access to setup mode ([Section 4.1 on page 21](#)).

1. Press . $\text{RUD}_1 \text{E}$ displays.
2. Press . SEtUP displays.
3. Press . CONF displays.
4. Press  to scroll until PrOUr displays.
5. Press . PURPN displays.
6. Press  to scroll until Ud displays.
7. Press . The current unit ID value displays.
8. Edit the value using the keypad ([Section 3.3.1 on page 15](#)).
9. Press  when the value is correct.
10. Press  to return to weigh mode.

3.4.16 View and Edit Time Value

To view and edit the current time:

1. Press . $\text{RUD}_1 \text{E}$ displays.
2. Press  multiple times until EtNE displays.
3. Press  to view the current set time.
4. To edit the time value use the following method:
 - Press  to clear the current time
 - Use the numeric keypad to enter the new time value
 - Press  to accept the new time value once correct
5. Press  to return to weigh mode.









NOTE: Time is backed up by the internal battery and is not lost if the main power is interrupted.

NOTE: See [Section 4.4.5 on page 30](#) for time formatting options.

3.4.17 View and Edit Date Value

To view and edit the current date:





1. Press . RUd, t displays.
2. Press  multiple times until $dPEE$ displays.
3. Press  to view the current set date.
4. To edit the date value use the following method:
 - Press  to clear the current date
 - Use the numeric keypad to enter the new date value and press  to accept the desired value
5. Press  to return to weigh mode.



NOTE: Date is backed up by the internal battery and is not lost if the main power is interrupted.
NOTE: See [Section 4.4.5 on page 30](#) for date formatting options.







3.4.18 View Configured Setpoint Values

See [Section 9.0 on page 57](#) more information.









1. Press . RUd, t displays.
2. Press  twice. $SEEPn$ displays.
3. Press . The lowest configured setpoint number displays.
4. Press  to navigate to the desired setpoint number (1-8).



NOTE: Only configured setpoint numbers display. Displayed setpoints are read only unless access is set to on.
NOTE: See [Section 4.4.8 on page 35](#) for the complete setpoint menu.

5. Press . $uRLUE$ displays.
6. Press  again to view the current configured setpoint value.
7. To edit the setpoint value use the following method:
 - Press  to clear the current value
 - Use the numeric keypad to enter the new value and press  to accept it
 - Press  to accept the new value once correct
8. Press  to return to weigh mode.

3.4.19 Reset Configuration

1. Access setup mode via the setup jumper ([Figure 4-1 on page 21](#)). $CONF, U$ displays.
2. Press . $dFLtCFU$ displays.
3. Press . no displays.
4. Press . $YE5$ displays.
5. Press  or  to reset the configuration setting. oF displays.
6. Press  or . no displays again.
7. Press  to return to weigh mode.

4.0 Configuration

There are two types of configuration parameters in the 680HE, setup mode parameters (or Legal for Trade configuration) and user mode parameters (or non-legal configuration). Setup mode parameters are accessed by the setup jumper (Section 4.1). User mode parameters are accessed by pressing the menu button and do not require the setup jumper for access.

The following sections provide graphic representations of the 680HE menu structures. Most menu diagrams are accompanied by a table which describes all parameters and parameter values associated with the menu. The factory default setting appear in bold type within the tables.

The audit, setpoints, accumulator, tare, time, date, Mac ID and version menus can be accessed by pressing .

 **NOTE:** The top-level setpoints menu displays the setpoint value of configured setpoints and is accessible with the menu button. Complete configuration of setpoints is under the setup menu and requires the setup jumper for access.

The setup menu is accessed with the setup jumper (Section 4.1).

 **NOTE:** All weight related parameters must be configured prior to calibrating the unit.

4.1 Setup Jumper

In order to fully configure the 680HE, it must be placed in setup mode with the setup jumper. The setup jumper can only be accessed by opening the enclosure.

 **IMPORTANT:** Use anti-static protection for grounding and to protect components from electrostatic discharge (ESD) when working inside the 680HE enclosure. Procedures requiring work inside the 680HE must be performed by qualified service personnel only.

To place the 680HE into setup mode, temporarily short the setup jumper (J25). The 680HE enters setup mode by accessing the setup menu and \square \square \square displays. See Section 4.4 on page 23 for a detailed breakdown of the setup menu.

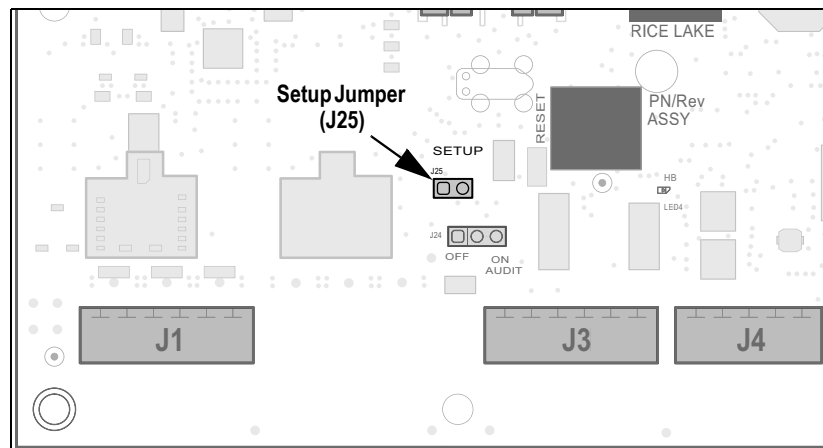



Figure 4-1. Setup Jumper Location on CPU Board

4.1.1 Audit Jumper

The audit jumper (J24) enables audit mode. Access to setup mode is allowed by pressing  when the audit jumper is in the ON position. When the audit jumper is in the OFF position, access to setup mode requires a temporary short of the setup jumper (J25).

 **NOTE:** In certain Legal for Trade applications it is necessary to seal the indicator (Section 2.6 on page 12) to restrict access to setup mode. Breaking of the seal terminates the Legal for Trade status of the indicator.

4.2 Main Menu



Figure 4-2. Main Menu

Menu	Description
AUDIT	Audit – Displays the legally relevant firmware version and allows access to view/print audit trail information; See Section 4.3
SETUP	Setup – Set configuration parameters for indicator (only accessible in setup mode); See Section 4.4 on page 23
SETPOINT	Setpoints – Displays the setpoint value of configured setpoints; Read only unless access parameter for the setpoint is set to ON; Setpoints are fully configurable in the setup menu while the indicator is in setup mode
ACCUM	Accumulator – Displays, prints and clears accumulated weight value; See Section 4.5 on page 39
TARE	Tare – Displays and clears stored tare value; See Section 4.6 on page 39
TIME	Time – Displays the time and allows the time to be edited (24-hour)
DATE	Date – Displays the date and allows the date to be edited
MAC ID	Mac ID – Displays the Mac ID of the Ethernet Communications Interface (read only)
VERSION	Version – Displays the installed firmware version number

Table 4-1. Main Menu Descriptions

4.3 Audit Menu

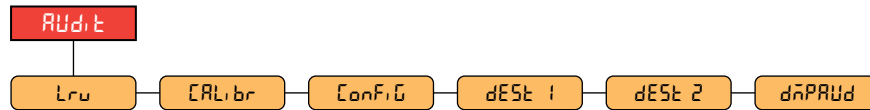

Figure 4-3. Audit Menu

Parameter	Description
LRV	LRV – Legally relevant firmware version
CALIBR	Calibration – Displays total number of calibration events (read only)
CONFIG	Configuration – Displays total number of configuration events (read only)
DEST 1	Destination Port 1 – Audit trail port; Settings: RS2321 (default), RS2322, RS485, TCPC, TCPS, USB, NONE
DEST 2	Destination Port 2 – Audit trail port; Settings: NONE (default), RS2321, RS2322, RS485, TCPC, TCPS, USB
DUMP	Dump Audit Trail – Prints the audit parameters to the configured port

Table 4-2. Audit Menu Descriptions

4.4 Setup Menu

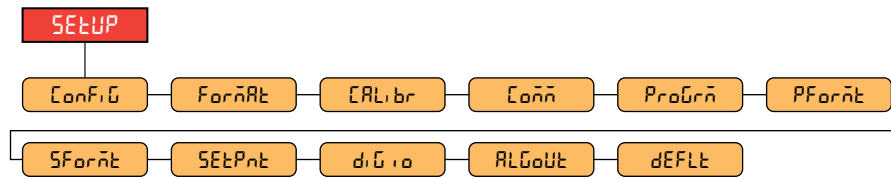

Figure 4-4. Setup Menu

Menu	Description
CONFIG	Configuration – See Section 4.4.1 on page 23 for menu structure and parameter descriptions of the Configuration menu
Format	Format – See Section 4.4.2 on page 25 for menu structure and parameter descriptions of the Format menu
Calibr	Calibration – See Section 4.4.3 on page 25 for menu structure and parameter descriptions of the Calibration menu
Comm	Communication – See Section 4.4.4 on page 26 for menu structure and parameter descriptions of the Communication menu
Program	Program – See Section 4.4.5 on page 30 for menu structure and parameter descriptions of the Program menu
Print	Print Format – See Section 4.4.6 on page 33 for menu structure and parameter descriptions of the Print Format menu
Stream	Stream Format – See Section 4.4.7 on page 34 for menu structure and parameter descriptions of the Stream Format menu
Setpoints	Setpoints – See Section 4.4.8 on page 35 for menu structure and parameter descriptions of the Setpoint menu
Digital I/O	Digital I/O – See Section 4.4.9 on page 38 for menu structure and parameter descriptions of the Digital I/O menu
Analog Output	Analog Output – See Section 4.4.10 on page 38 for menu structure and parameter descriptions of the Analog Output menu
Default	Default Configuration – See Section 3.4.19 on page 20 for instructions to reset the configuration settings

Table 4-3. Setup Menu Descriptions

4.4.1 Setup – Configuration Menu

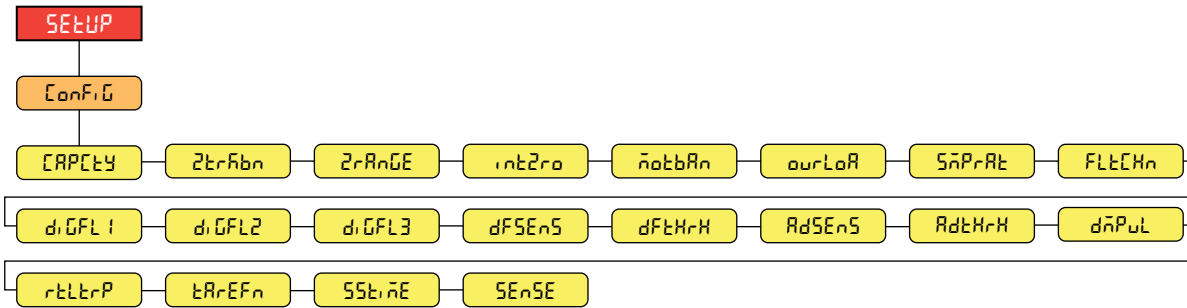

Figure 4-5. Setup – Configuration Menu

Menu	Description
CAPACITY	Capacity – Maximum rated capacity of the scale; Enter value: 0.00001–999999.0, 10000.0 (default)
Zero Track Band	Zero Track Band – Automatically zeros the scale when within the range specified, as long as the input is within the Zero Range and scale standstill; When weight is within the zero band, the center of zero annunciator displays; Max legal value depends on local regulations; Specify the zero tracking band in ± display divisions; Enter value: 0.0–100.0, 0.0 (default)
Zero Range	Zero Range – The total amount the scale can be zeroed; Zero range represents a percentage of capacity; The default value of 1.9 represents ±1.9% around the calibrated zero point, for a total range of 3.8%; A value of 0.0 prevents zeroing; Maximum legal value depends on local regulations; Enter value: 0.0–100.0, 1.9 (default)
Initial Zero Range	Initial Zero Range – When the indicator is turned on and the weight value is between the ± percent range specified in Calibrated Zero, the indicator automatically zeros off the weight; Enter value: 0.0–100.0, 0.0 (default)
Motion Band	Motion Band – Sets the level, in display divisions, at which scale motion is detected; If motion is not detected for the time defined by S5 tRE, the standstill symbol lights; Some operations, including print, tare, and zero, require the scale to be at standstill; Maximum legal value varies depending on local regulations; If this parameter is set to 0, the standstill annunciator is always lit and operations requiring standstill are performed regardless of scale motion; If 0 is selected, Zero Track Band must also be set to 0; Enter value: 0–100, 1 (default)
Overload	Overload – Determines the point at which the display blanks and the overload error message displays (^^^^); Maximum legal value varies depending on local regulations; Settings: FS+2% (default), FS+1D, FS+9D, FS

Table 4-4. Setup – Configuration Menu Descriptions

Menu	Description
5nPrRE	Sample Rate – Selects measurement rate, in samples per second, of the analog-to-digital converter; Lower sample rate values provide greater signal noise immunity; <i>Settings:</i> 6.25HZ, 7.5HZ, 12.5HZ, 15HZ, 25HZ, 30HZ (default), 50HZ, 60HZ, 100HZ, 120HZ
FLEEHn	Filter Chain Type – Sets the filter type to be used; <i>Settings:</i> AVGONL (default) – Digital Rolling Average Filter (Section 11.7.1 on page 68); Uses DIGFL1-3, DFSENS and DFTHRH ADPONL – Adaptive Filter (Section 11.7.2 on page 69); Uses ADSENS and ADTHRH DMPONL – Damping Filter (Section 11.7.3 on page 70); Uses DMPVL RAW – No filtering
d,GFLL1-3	Digital Filters – Sets the digital filtering rate used to reduce the effects of environmental influences from the immediate area of the scale; <i>Settings</i> indicate the number of A/D conversions per update which are averaged to obtain the displayed reading; a higher number gives a more accurate display by minimizing the effect of a few noisy readings, but slows down the response time of the indicator; <i>Settings:</i> 1, 2, 4 (default), 8, 16, 32, 64, 128, 256
dF5En5	Digital Filter Sensitivity – Specifies the number of consecutive A/D readings which fall outside the Filter Threshold before filtering is suspended; <i>Settings:</i> 2OUT (default), 4OUT, 8OUT, 16OUT, 32OUT, 64OUT, 128OUT
dFtHrH	Digital Filter Threshold – Sets a threshold value, in display divisions; when a number of consecutive A/D readings (Digital Filter Sensitivity) falls outside of this threshold value (when compared to the output of the filter), filtering is suspended and the A/D value is sent straight through the filter; Filtering is not suspended if the threshold is set to NONE; <i>Settings:</i> NONE (default), 2D, 5D, 10D, 20D, 50D, 100D, 200D, 250D
Rd5En5	Adaptive Filter Sensitivity – Controls the stability and response time of the scale; <i>Settings:</i> LIGHT (default) – Fastest response to small weight changes, but less stable MEDIUM – Has a quicker response time than heavy, but more stable than light HEAVY – Results in an output which is more stable but settles slowly; small changes in weight data (a few grads) on the scale base are not seen quickly
RdtHrH	Adaptive Filter Threshold – Sets the adaptive filter weight threshold value (in display divisions); a weight change exceeding the threshold resets the filtered values; must be set above the noise disturbances in the system (if set to zero, the filter is disabled); <i>Enter value:</i> 0–2000, 10 (default)
dnPUL	Damping Value – Sets the damping time constant (in 0.1 sec intervals); <i>Enter value:</i> 1–2560, 10 (default)
rELtEP	RattleTrap – Enables RattleTrap filtering; Effective at eliminating vibration effects, environmental influences and mechanical interference from nearby machinery, may increase response time over standard digital filtering; <i>Settings:</i> OFF (default), ON
tRrEFn	Tare Function – Enables or disables push-button and keyed tare; <i>Settings:</i> BOTH (default) – Both push-button and keyed tare are enabled NOTARE – No tare allowed (gross mode only) PBTARE – Push-button tares enabled KEYED – Keyed tare enabled
5St, nE	Standstill Time – Specifies the length of time the scale must be out of motion, before the scale is considered to be at standstill (in 0.1 sec intervals); <i>Enter value:</i> 0–600, 10 (default)
5En5E	Sense – Specifies the type of load cell cable connected to the J1 connector (Section 2.4.5 on page 7); <i>Settings:</i> 4-WIRE (default), 6-WIRE

Table 4-4. Setup – Configuration Menu Descriptions (Continued)

4.4.2 Setup – Format Menu

4.4.2.1 Primary and Secondary Menus

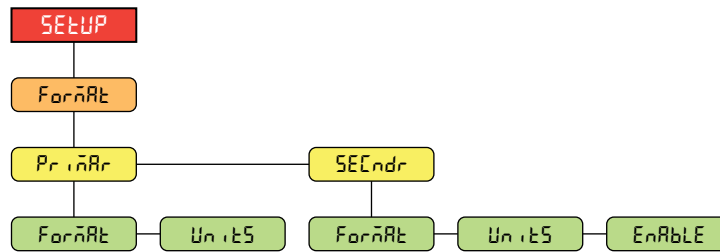

Figure 4-6. Format – Primary and Secondary Menus

Parameter	Description
Format	Format – Sets the decimal point and the display divisions for the Primary (Primary) and Secondary (Secondary) display weight format; For example, select 8888.885 if a count by of 0.005 is needed or select 888820 if a count by of 20 is needed (the 8s serve as placeholders and show a breakdown of how digits will display); Settings: 888881 (Primary default), 888882, 888885, 888810, 888820, 888850, 888100, 888200, 888500, 88.8881, 88.8882, 88.8885, 888.881, 888.882, 888.885, 8888.81, 8888.82, 8888.85, 88888.1, 88888.2, 88888.5 (Secondary default)
Units	Units – Sets the units type; Settings: LB (Primary default), KG (Secondary default), OZ, TN, T, G, NONE
Enable	Enable – Enables the front panel UNITS button to toggle between the primary and secondary formats (only displays under Secondary); Settings: ON (default), OFF

Table 4-5. Format – Primary and Secondary Menu Parameters

4.4.3 Setup – Calibration Menu

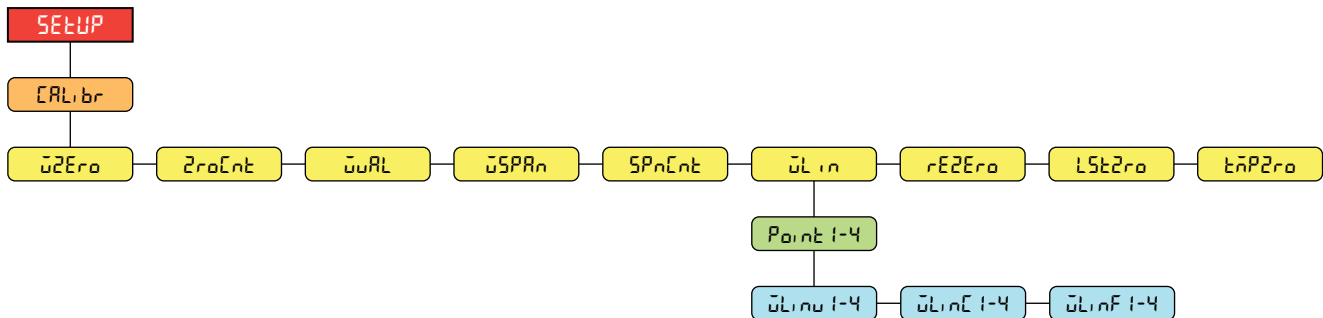

Figure 4-7. Setup – Calibration Menu

Parameter	Description
Zero	Zero Calibration – Executes the zero calibration process; See Section 5.1 on page 40
Count	Zero Calibration Count – Displays the raw count value at the zero weight; A zero calibration (WZERO) generates this raw count value; Manually changing this count value changes the zero weight and negates the zero calibration
WRL	Test Weight Value – Sets the weight value for the span calibration; See Section 5.1 on page 40 ; Enter value: 0.00001–999999.0, 10000.0 (default)
WSPAN	Span Calibration – Executes the span calibration process; See Section 5.1.1 on page 40
Span	Span Calibration Count – Displays the raw count value at the span weight; A span calibration (WSPAN) generates this raw count value; Manually changing this count value changes the span weight and negates the span calibration

Table 4-6. Setup – Calibration Menu Parameter

Parameter	Description
WLIn	Linear Calibration – A linear or multi-point calibration is performed by entering up to four additional calibration points; See Section 5.1.2 on page 41 WLINV# – Sets the test weight value for linear calibration point WLINC# – Executes the linear calibration process for the point; generates the raw count value (F) for the test weight value (V) WLINF# – Displays the raw count value at the linear point weight; A linear calibration (WLINC#) generates this raw count value; Manually changing this count value changes the linear point weight and negates the linear calibration for the point
rEZEro	Rezero – Removes an offset value from the zero and span calibrations; See Section 5.2.3 on page 41
LStZro	Last Zero – Takes the last pushbutton zero in the system (from weigh mode) and uses it as the new zero reference point, after which a new span calibration must be performed; This calibration cannot be performed when calibrating a scale for the first time; See Section 5.2.1 on page 41
tñPZro	Temporary Zero – Temporarily zeros the displayed weight of a non-empty scale, after a span calibration was performed; The difference between the temporary zero and the previously calibrated zero value is used as an offset; See Section 5.2.2 on page 41

Table 4-6. Setup – Calibration Menu Parameter (Continued)

4.4.4 Setup – Communication Menu

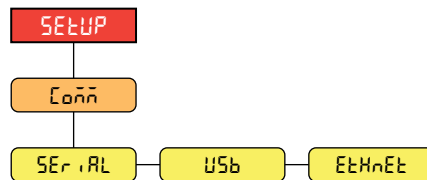

Figure 4-8. Setup – Communication Menu

Menu	Description
SERIAL	Serial Port – Supports RS-232 and RS-485/422 serial communications; See Section 4.4.4.1 on page 27
USB	USB – Intended to be connected to a PC only; appears as a Virtual COM Port and is assigned a “COMx” designation; applications communicate through the port like a standard RS-232 communications port; See Section 4.4.4.2 on page 28
Ethernet	Ethernet – Features Ethernet TCP/IP 10Base-T/100Base-TX communication and can support two simultaneous connections, one as a server, the other as a client; See Section 4.4.4.3 on page 29

Table 4-7. Setup – Communication Menu Descriptions

4.4.4.1 Serial Port Menu

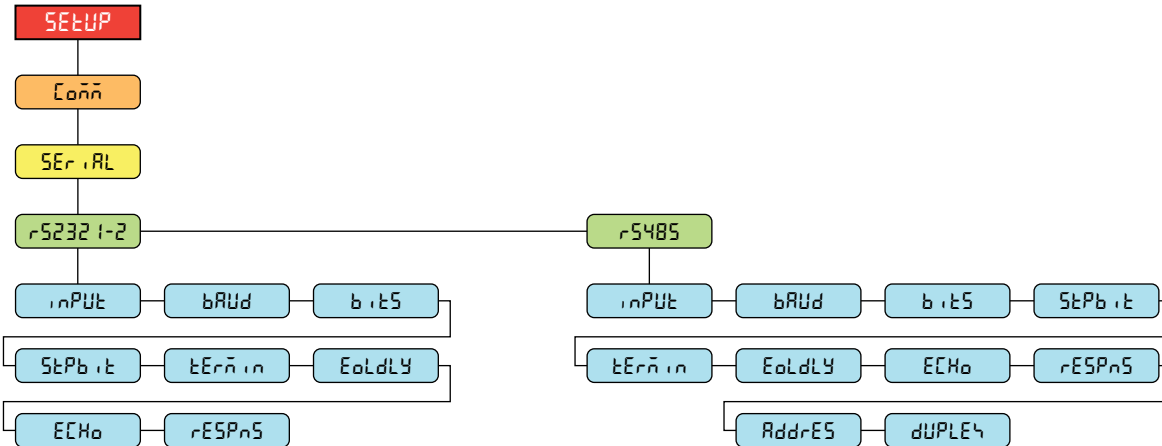

Figure 4-9. Communication – Serial Port Menu

Parameter	Description
iNPUt	Input – Sets the input trigger type; Settings: CMD (default) – Command: setting input trigger to command allows operation of EDP commands and can print STRIND – Stream Industrial Scale Data: data is updated up to the configured sample rate; allows operation of EDP commands and printing STRLFT – Stream Legal for Trade Data: data is updated at the configured display update rate; allows operation of EDP commands and printing REMOTE – Configures the port to operate as a serial scale input NOTE: When in STRIND, STRLFT and REMOTE, if the address is set to 0 (rs422 mode)
bAUD	Baud Rate – Sets the transmission speed for the port; Settings: 1200, 2400, 4800, 9600 (default), 19200, 28800, 38400, 57600, 115200
b.i.t5	Data Bits – Sets number of data bits transmitted or received by the port and specifies the parity bit to odd, even or none; Settings: 8NONE (default), 7EVEN, 7ODD, 8EVEN, 8ODD
StPbit	Stop Bits – Sets the number of stop bits transmitted or received by the port; Settings: 1 (default), 2
tErmin	Outgoing Line Termination – Sets the termination character for data sent from the port; Settings: CR/LF (default), CR
EoLdLY	End of Line Delay – Sets the delay period from when a formatted line is terminated to the beginning of the next formatted serial output (0.1- second intervals); Enter value: 0–255, 0 (default)
ECHo	Echo – Specifies if characters received by the port are echoed back to the sending unit; Settings: ON (default), OFF
rESPn5	Response – Specifies if the port transmits replies to serial commands; Settings: ON (default), OFF
AdDrES	Address – Specifies address used to connect to the port (RS-485 only); Enter value: 0–255, 0 (default)
dUPLEx	Duplex – Specifies FULL (4-wire) or HALF (2-wire) duplex used to connect to the port (RS-485/422 only); Settings: FULL (default), HALF

Table 4-8. Communication – Serial Port Menu Parameters

4.4.4.2 USB Menu

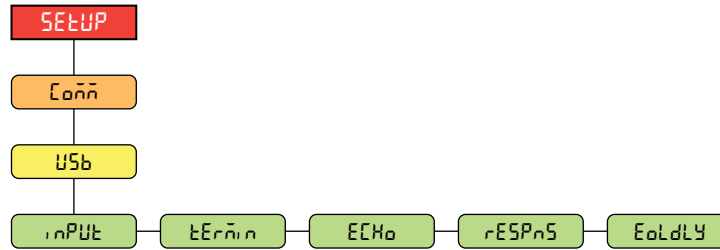

Figure 4-10. Communication – USB Menu

Parameter	Description
iNPUT	Input – Sets the input trigger type; <i>Settings:</i> CMD (default) – Command: setting input trigger to command allows operation of EDP commands and can print STRIND – Stream Industrial Scale Data: data is updated up to the configured sample rate; allows operation of EDP commands and printing STRLFT – Stream Legal for Trade Data: data is updated at the configured display update rate; allows operation of EDP commands and printing REMOTE – Configures the port to operate as a serial scale input
tErmin	Outgoing Line Termination – Sets the termination character for data sent from the port; <i>Settings:</i> CR/LF (default), CR
ECHo	Echo – Specifies if characters received by the port are echoed back to the sending unit; <i>Settings:</i> ON (default), OFF
rESPnS	Response – Specifies if the port transmits replies to serial commands; <i>Settings:</i> ON (default), OFF
EoLdLY	End of Line Delay – Sets the delay period from when a formatted line is terminated to the beginning of the next formatted serial output (0.1- second intervals); <i>Enter value:</i> 0–255, 0 (default)

Table 4-9. Communication – USB Menu Parameters

4.4.4.3 Ethernet Menu

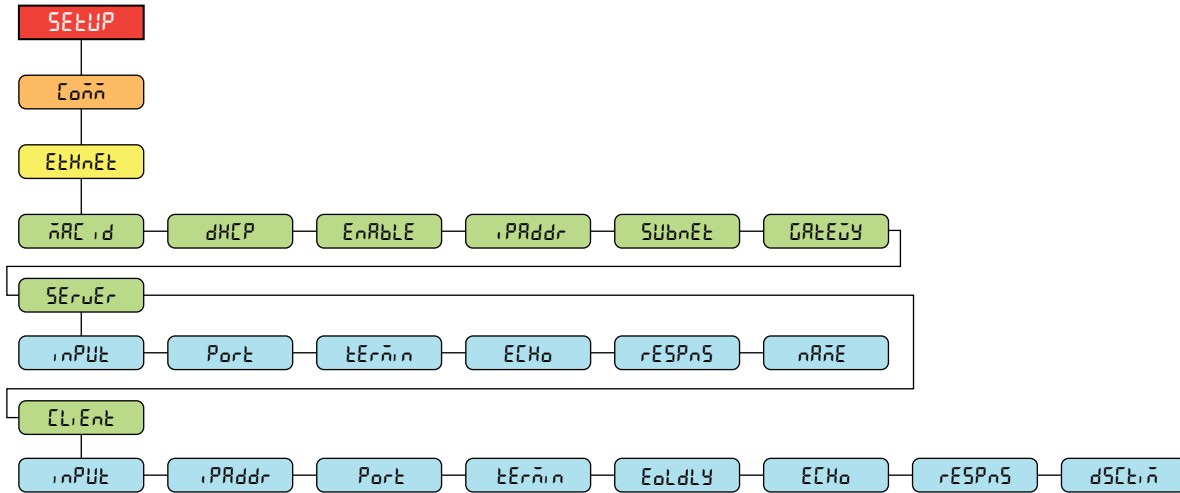

Figure 4-11. Communication – Ethernet Menu

Parameter	Description
ñRE id	Displays the Ethernet MAC address (read only): 00:00:00:00:00:00
dHCP	DHCP – Dynamic Host Configuration Protocol (static allocation of IP address when OFF); Settings: ON (default), OFF
EnAbLE	Enable – Enables Ethernet communications; Settings: OFF (default), ON
iPRddr	IP Address; Enter value: 0.0.0.0 (default)
SÜbnEt	Subnet Mask; Enter value: 255.255.255.0 (default)
GRtEÜY	Default Gateway; Enter value: 0.0.0.0 (default)
SEruEr	Ethernet Server – Allows the 680HE to receive external EDP commands; Sub-parameters: INPUT – Sets the input trigger type; Settings: CMD (default), STRIND, STRLFT, REMOTE PORT – Specifies IP Address port to open to establish communications; Enter value: 1025–65535, 10001 (default) TERMIN – Line Termination: Sets the termination character for data sent from the port; Settings: CR/LF (default), CR ECHO – Specifies if characters received by the port are echoed back to the sending unit; Settings: OFF (default), ON RESPNS – Specifies if the port transmits replies to serial commands; Settings: ON (default), OFF NAME – Name for Ethernet Server; Enter characters: Alphanumeric entry up to 30 characters, 0 (default)
CLiEnt	Ethernet Client – Allows the 680HE to send EDP commands to external devices; Sub-parameters: INPUT – Sets the input trigger type; Settings: CMD (default), STRIND, STRLFT, REMOTE IPADDR – IP Address; Enter value: 0.0.0.0 (default) PORT – Specifies IP Address port to look for to establish communications; Enter value: 1025–65535, 10001 (default) TERMIN – Line Termination: Sets the termination character for data sent from the port; Settings: CR/LF (default), CR EOLDLY – End of Line Delay: Sets the delay period from when a formatted line is terminated to the beginning of the next formatted serial output (0.1- second intervals); Enter value: 0–255, 0 (default) ECHO – Specifies if characters received by the port are echoed back to the sending unit; Settings: ON (default), OFF RESPNS – Specifies if the port transmits replies to serial commands; Settings: ON (default), OFF DSCTIM – Disconnect Timeout (in seconds); 0= Do not Disconnect; Enter value: 0–60, 0 (default)

Table 4-10. Communication – Ethernet Menu Parameters

4.4.5 Setup – Program Menu

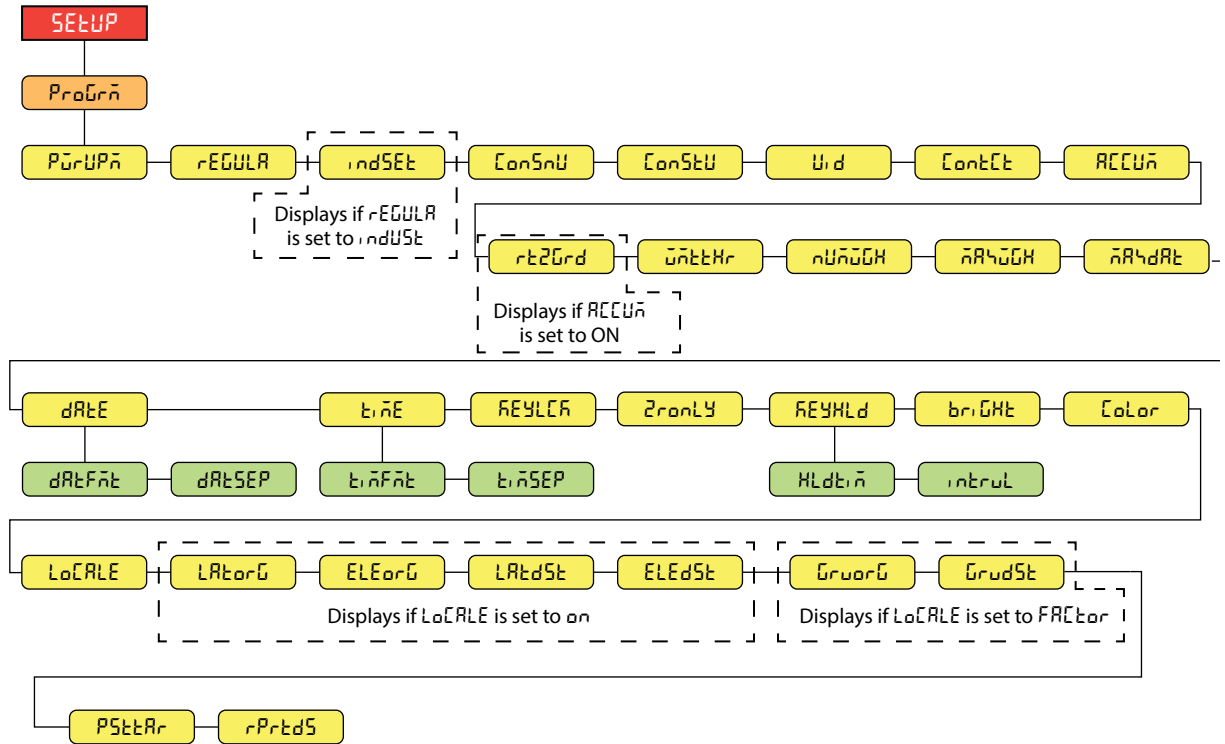

Figure 4-12. Setup – Program Menu

Parameter	Description
PwrUPn	Power Up Mode – When the indicator is turned on, it performs a display test, then enters a warm up period; <i>Settings:</i> GO (default) – Performs display test, then enters weigh mode after brief warm up period DELAY – Performs display test, then enters a warm up period of 30 seconds <ul style="list-style-type: none"> • If no motion is detected during warm up period, indicator enters weigh mode when warm up period ends • If motion is detected, the 30 second timer is reset and the warm up period is repeated
REGULAR	Regulatory Mode – Specifies the regulatory agency having jurisdiction over the scale site; the value specified for this parameter affects the function of the front panel tare and zero keys; <i>Settings:</i> NTEP (default), OIML, CANADA, INDUST, NONE <ul style="list-style-type: none"> • OIML, NTEP, and CANADA modes allow a tare to be acquired at a weight greater than zero; NONE allows tares to be acquired at any weight value • OIML, NTEP, and CANADA modes allow a tare to be cleared only if the gross weight is at no load; NONE allows tares to be cleared at any weight value • NTEP and OIML modes allow a new tare to be acquired even if a tare is already present; In CANADA mode, the previous tare must be cleared before a new tare can be acquired • NONE, NTEP and CANADA modes allow the scale to be zeroed in either gross or net mode as long as the current weight is within the specified ZRANGE; In OIML mode, the scale must be in gross mode before it can be zeroed; pressing the ZERO key in net mode clears the tare • INDUST provides a set of sub-parameters to allow customization of tare, clear, and print functions in non Legal-for-Trade scale installations
INDUST	Industrial Settings – Displays when REGULA parameter is set to INDUST; See Section 4.4.5.2 on page 32
CONSNU	Consecutive Numbering – Allows sequential numbering for print operations; the value is incremented following each print operation which includes <CN> in the ticket format; <i>Enter value:</i> 0–999999, 0 (default)
CONSBU	Consecutive Number Startup Value – Specifies the initial consecutive number (CONSNU) value used when the consecutive number is reset by sending CLRCN digital input; <i>Enter value:</i> 0–999999, 0 (default)
UId	Unit ID – Specifies the unit identification number with an alphanumeric value; <i>Enter characters:</i> Up to 8 alphanumeric characters, 1 (default)
ContCt	Contact Information; See Section 4.4.5.1 on page 32

Table 4-11. Setup – Program Menu Parameters

Parameter	Description
ᐃᑦᑕᑦᑎ	Accumulator – Accumulation can be toggled ON/OFF; if ON, accumulation occurs on print operation; if OFF, an accumulation does not occur; <i>Settings: OFF (default), ON</i>
ᑦᑦᑕᑦᑎᑦᑎ	Return to Zero Graduations – Number of graduations from the zero base at which the accumulator re-arms itself (only visible if the Accumulator is set to ON); <i>Enter value: 0.0–100.0, 0.4 (default)</i>
ᑦᑦᑕᑦᑎᑦᑎᑦᑎ	Weightment Threshold – The weight that when exceeded is counted as a weightment.; <i>Enter value: 0.0–99999.0, 1000.0 (default)</i>
ᑦᑦᑕᑦᑎᑦᑎᑦᑎ	Number of Weightments – Displays the total number of weightments; <i>Read only</i>
ᑦᑦᑕᑦᑎᑦᑎᑦᑎ	Maximum Weightment – Displays the maximum weightment achieved; <i>Read only</i>
ᑦᑦᑕᑦᑎᑦᑎᑦᑎ	Date/Time of Max Weight – Displays the date and time the maximum weightment occurred; <i>Read only</i>
ᑦᑦᑕᑦᑎᑦᑎᑦᑎ	Date – Allows setting of the date format and date separator character DATFMT – Date Format; <i>Settings: MMDDYY (default), DDMMYY, YYMMDD, YYDDMM</i> DATSEP – Date Separator; <i>Settings: SLASH (default), DASH, SEMI, DOT</i>
ᑦᑦᑕᑦᑎᑦᑎᑦᑎ	Time – Allows setting of the time format and the separator character TIMFMT – Time Format; <i>Settings: 12HOUR (default), 24HOUR</i> TIMSEP – Time Separator; <i>Settings: COLON (default), COMMA, DOT</i>
ᑦᑦᑕᑦᑎᑦᑎᑦᑎ	Keyboard Lock - Disables the keyboard except for the power key; <i>Settings: OFF (Default), ON</i>
ᑦᑦᑕᑦᑎᑦᑎᑦᑎ	Zero Only – Disables the keyboard except for the zero, menu and power keys - OFF (default), ON
ᑦᑦᑕᑦᑎᑦᑎᑦᑎ	Key Hold – Allows setting of the key hold time and interval HLDTIME – Keyhold time (in tenths of a second); how long a key needs to be held before a key hold action is initiated; 20 equals 2 seconds; <i>Enter value: 10–50, 20 (default)</i> INTERVL – Key hold time interval (in twentieths of a second); the amount of time between increments during a key hold; 2 equals a tenth of a second (10 increments per second during a key hold); <i>Enter value: 1–100, 2 (default)</i>
ᑦᑦᑕᑦᑎᑦᑎᑦᑎ	Color – Specifies the color of the display digits; <i>Settings: RED (default), GREEN</i>
ᑦᑦᑕᑦᑎᑦᑎᑦᑎ	Brightness – Specifies the brightness level of the display digits; <i>Settings: LOW (default), HIGH</i>
ᑦᑦᑕᑦᑎᑦᑎᑦᑎ	Location Gravity Compensation – Enables gravity compensation; <i>Settings:</i> OFF (default) – gravity compensation disabled ON – calculates gravity compensation using the origin and destination latitudes and elevations FACTOR – uses origin and destination gravity factors to find gravity compensation
ᑦᑦᑕᑦᑎᑦᑎᑦᑎ	Latitude of Origin – Original latitude (to nearest degree) for gravity compensation; displays when LOCALE parameter is set to ON; <i>Enter value: 0–90, 45 (default)</i>
ᑦᑦᑕᑦᑎᑦᑎᑦᑎ	Elevation of Origin – Original elevation (in meters) for gravity compensation; displays when LOCALE parameter is set to ON; <i>Enter value: -9999–9999, 345 (default)</i>
ᑦᑦᑕᑦᑎᑦᑎᑦᑎ	Latitude of Destination – Destination latitude (to nearest degree) for gravity compensation; displays when LOCALE parameter is set to ON; <i>Enter value: 0–90, 45 (default)</i>
ᑦᑦᑕᑦᑎᑦᑎᑦᑎ	Elevation of Destination – Destination elevation (in meters) for gravity compensation; displays when LOCALE parameter is set to ON; <i>Enter value: -9999–9999, 345 (default)</i>
ᑦᑦᑕᑦᑎᑦᑎᑦᑎ	Gravity of Origin – Original gravity factor (in m/s ²) for gravity compensation; displays when LOCALE parameter is set to FACTOR; <i>Enter value: 9.00000–9.99999, 9.80665 (default)</i>
ᑦᑦᑕᑦᑎᑦᑎᑦᑎ	Gravity of Destination – Destination gravity factor (in m/s ²) for gravity compensation; displays when LOCALE parameter is set to FACTOR; <i>Enter value: 9.00000–9.99999, 9.80665 (default)</i>
ᑦᑦᑕᑦᑎᑦᑎᑦᑎ	Persistent Tare – Saves the tare value of scale on power cycle; <i>Settings: Off (default), On</i>
ᑦᑦᑕᑦᑎᑦᑎᑦᑎ	Remote Print Destination – Determines which indicator in the local/remote setup performs the print action; <i>Settings: REMOTE, LOCAL (default)</i>

Table 4-11. Setup – Program Menu Parameters (Continued)

4.4.5.1 Contact Information Menu

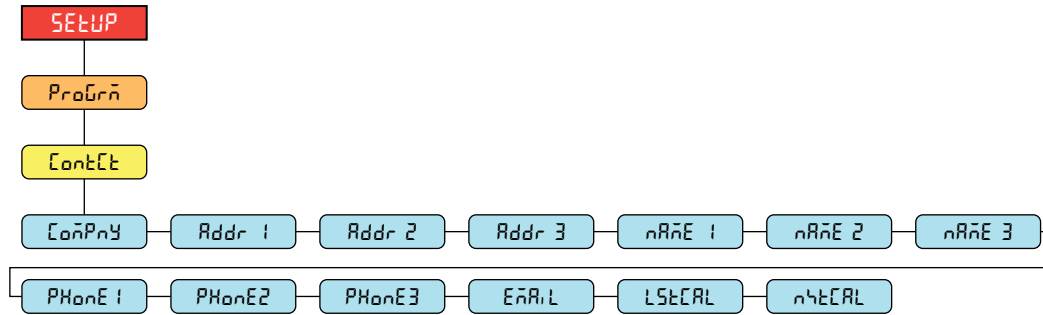

Figure 4-13. Contact Information Menu

Parameter	Description
Company	Company – Contact company name; <i>Enter characters: Alphanumeric entry up to 30 characters</i>
Addr 1-3	Address – Contact company address lines; <i>Enter characters: Alphanumeric entry up to 20 characters (for each line)</i>
Name 1-3	Name – Contact names; <i>Enter characters: Alphanumeric entry up to 30 characters (for each line)</i>
Phone 1-3	Phone – Contact phone numbers; <i>Enter characters: Alphanumeric entry up to 20 characters (for each line)</i>
Email	Email – Contact email address; <i>Enter characters: Alphanumeric entry up to 40 characters</i>
Last Cal	Last Cal – Last calibration date; <i>Enter value: 8-digit number (MMDDYYYY)</i>
Next Cal	Next Cal – Next calibration date; <i>Enter value: 8-digit number (MMDDYYYY)</i>

Table 4-12. Contact Information Menu Parameters

4.4.5.2 Industrial Settings Menu

The industrial settings menu (indSEt) only displays if the regulation parameter (REGULR) is set to industrial (indUSt).

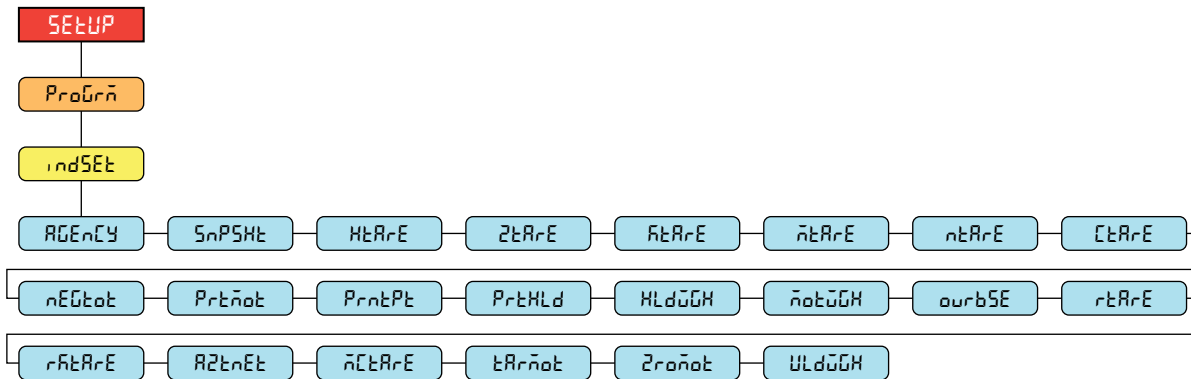

Figure 4-14. Industrial Settings Menu

Parameter	Description
Agency	Audit Agency – Audit trail display agency format; <i>Settings: NTEP (default), CANADA, NONE, OIML</i>
SnapShot	Snap Shot – Display or scale weight source; <i>Settings: DISPLAY (default), SCALE</i>
HoldTare	Hold Tare – Allow tare in display hold; <i>Settings: NO (default), YES</i>
ZeroTare	Zero Tare – Remove tare on zero; <i>Settings: NO (default), YES</i>
KeyedTare	Keyed Tare – Always allow keyed tare; <i>Settings: YES (default), NO</i>
MultipleTare	Multiple Tare – Replaces existing tare when the tare key is pressed; <i>Settings: REPLAC (default), REMOVE, NOTHING</i>
NegativeZeroTare	Negative/Zero Tare – Allow negative or zero tare; <i>Settings: NO (default), YES</i>
ClearTare	Clear Tare/Accumulator – Allow clear key to clear tare/accumulator; <i>Settings: YES (default), NO</i>
NegativeTotal	Negative Total – Allow total scale to display negative value; <i>Settings: NO (default), YES</i>
PrintInMotion	Print In Motion – Allow print while in motion; <i>Settings: NO (default), YES</i>
PrintPresetTare	Print Preset Tare – Add preset tare (PT) to keyed tare print; <i>Settings: YES (default), NO</i>

Table 4-13. Industrial Settings Menu Parameters

Parameter	Description
PrHld	Print Hold – Print during display hold; Settings: NO (default), YES
HldWGH	Hold Weighment – Allow weighment during display hold; Settings: NO (default), YES
MotWGH	Motion Weighment – Allow weighment in motion; Settings: NO (default), YES
ovrbSE	Overload Base – Zero base for overload calculation; Settings: CALIB (default), SCALE
rtrRE	Round Button Tare – Round pushbutton tare to the nearest display division; Settings: NO (default), YES
rkrRE	Round Keyed Tare – Round keyed tare to the nearest display division; Settings: NO (default), YES
RZtNEt	AZT On Net Value – Perform auto zero tracking on net value; Settings: NO (default), YES
ncRE	Manual Clear Tare – Allow manual clearing of the tare value; Settings: YES (default), NO
trMot	Tare In Motion – Allow tare in motion; Settings: NO (default), YES
ZrMot	Zero In Motion – Allow scale to be zeroed while in motion; Settings: NO (default), YES
UldWGH	Underload Weight – Underload weight value in display divisions; Enter value: 1–999999, 20 (default)

Table 4-13. Industrial Settings Menu Parameters (Continued)

4.4.6 Setup – Print Format Menu

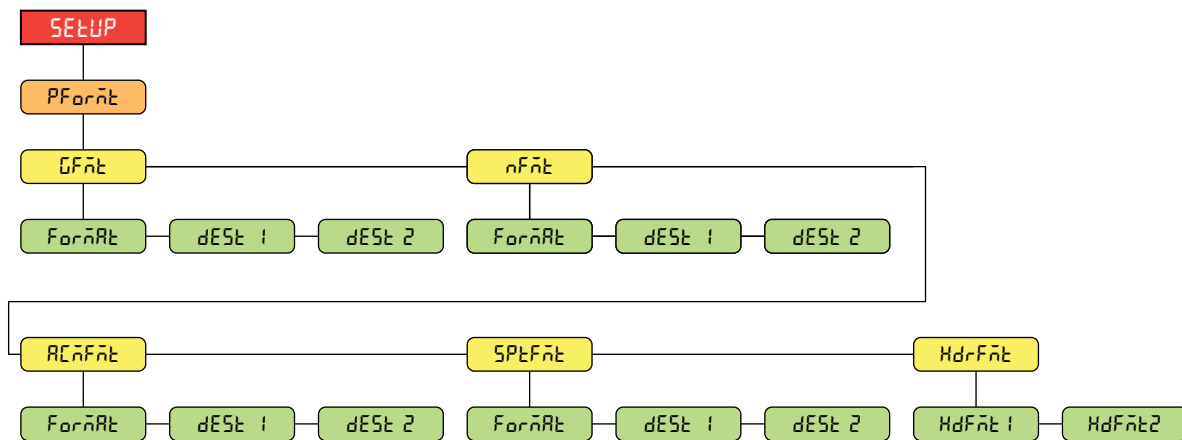

Figure 4-15. Setup – Print Format Menu

Parameter	Description
GFnt	Gross Format – Gross demand print format string FORMAT – Enter characters: Alphanumeric entry up to 1000 characters, Gross<g><n/2><td><n/ (default) DEST 1-2 – Destination ports; Settings: RS2321 (default), RS2322, RS485, TCPC, TCPS, USB, NONE (DEST 2 default)
nFnt	Net Format – Net demand print format string FORMAT – Enter characters: Alphanumeric entry up to 1000 characters, Gross<g><n/ Tare<sp><t><n/ Net<sp2><n><n/2><td><n/ (default) DEST 1-2 – Destination ports; Settings: RS2321 (default), RS2322, RS485, TCPC, TCPS, USB, NONE (DEST 2 default)
RCnFnt	Accumulator Format – Accumulator print format string FORMAT – Enter characters: Alphanumeric entry up to 1000 characters, Accum <a><n/ <da> <t/ <n/ (default) DEST 1-2 – Destination ports; Settings: RS2321 (default), RS2322, RS485, TCPC, TCPS, USB, NONE (DEST 2 default)
SPtFnt	Setpoint Format – Setpoint print format string FORMAT – Enter characters: Alphanumeric entry up to 1000 characters, <scv><sp><spm><n/ (default) DEST 1-2 – Destination ports; Settings: RS2321 (default), RS2322, RS485, TCPC, TCPS, USB, NONE (DEST 2 default)

Table 4-14. Setup – Print Format Menu Parameters

Parameter	Description
HdrFnt	Header Format – Ticket header format strings HDFMT1 – Header 1 Format String; Enter characters: Alphanumeric entry up to 1000 characters, Company Name<nl>Street Address<nl>City St Zip<nl2> (default) HDFMT2 – Header 2 Format String; Enter characters: Alphanumeric entry up to 1000 characters, Company Name<nl>Street Address<nl>City St Zip<nl2> (default)

Table 4-14. Setup – Print Format Menu Parameters (Continued)

4.4.7 Setup – Stream Format Menu

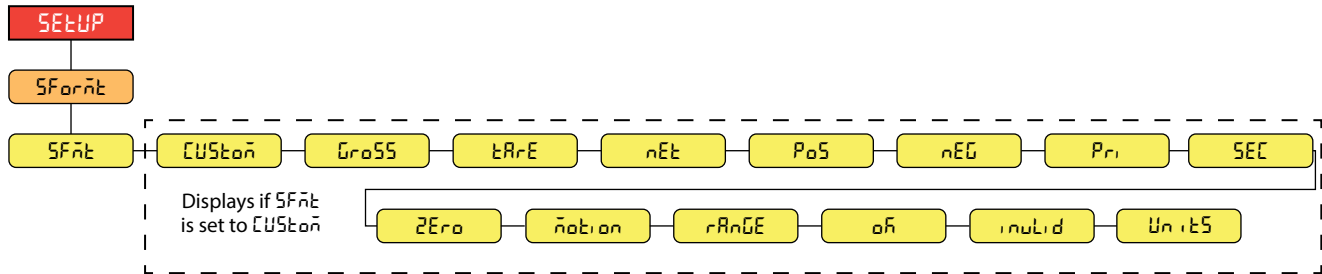

Figure 4-16. Setup – Stream Format Menu

Parameter	Description
SFnt	Stream Format – Specifies the stream format used for streaming output of scale data or specifies the expected input for a serial scale; Settings: RLWS (default) – Rice Lake Weighing Systems stream format (Section on page 64) CRDNAL – Cardinal stream format (Section on page 64) WTRNIX – Avery Weigh-Tronix stream format (Section on page 65) TOLEDO – Mettler Toledo stream format (Section on page 65) CUSTOM – Custom stream format
CUSTOM	Custom Stream Format – Specifies the custom stream format; only displays if SFMT is set to CUSTOM; Enter characters: Alphanumeric entry up to 1000 characters
Gross	Gross – Mode token when streaming the gross weight; Enter characters: Alphanumeric entry up to 8 characters, G (default)
Tare	Tare – Mode token when streaming the tare weight; Enter characters: Alphanumeric entry up to 8 characters, T (default)
Net	Net – Mode token when streaming the net weight; Enter characters: Alphanumeric entry up to 8 characters, N (default)
Pos	Positive – Polarity token when the weight is positive; Settings: SPACE (default), NONE, +
Neg	Negative – Polarity token when the weight is negative; Settings: SPACE , NONE, – (default)
Pri	Primary – Units token when streaming primary units; Enter characters: Alphanumeric entry up to 8 characters, L (default)
Sec	Secondary – Units token when streaming secondary units; Enter characters: Alphanumeric entry up to 8 characters, K (default)
Zero	Zero – Status token when the weight is at center of zero; Enter characters: Alphanumeric entry up to 2 characters, Z (default)
Motion	Motion – Status token when the weight is in motion; Enter characters: Alphanumeric entry up to 2 characters, M (default)
Range	Range – Status token when the weight is out of range; Enter characters: Alphanumeric entry up to 2 characters, O (default)
OK	OK – Status token when the weight is OK (not invalid, out of range, at zero or in motion); Enter characters: Alphanumeric entry up to 2 characters (default is a space)
Invalid	Invalid – Status token when streaming an invalid weight; Enter characters: Alphanumeric entry up to 2 characters, I (default)
Units	Units – Dynamic defaults to configured units of the scale and Static uses set Primary/Secondary unit tokens; Settings: DYNAMIC (default), STATIC

Table 4-15. Setup – Stream Format Menu Parameters

4.4.8 Setup – Setpoints Menu

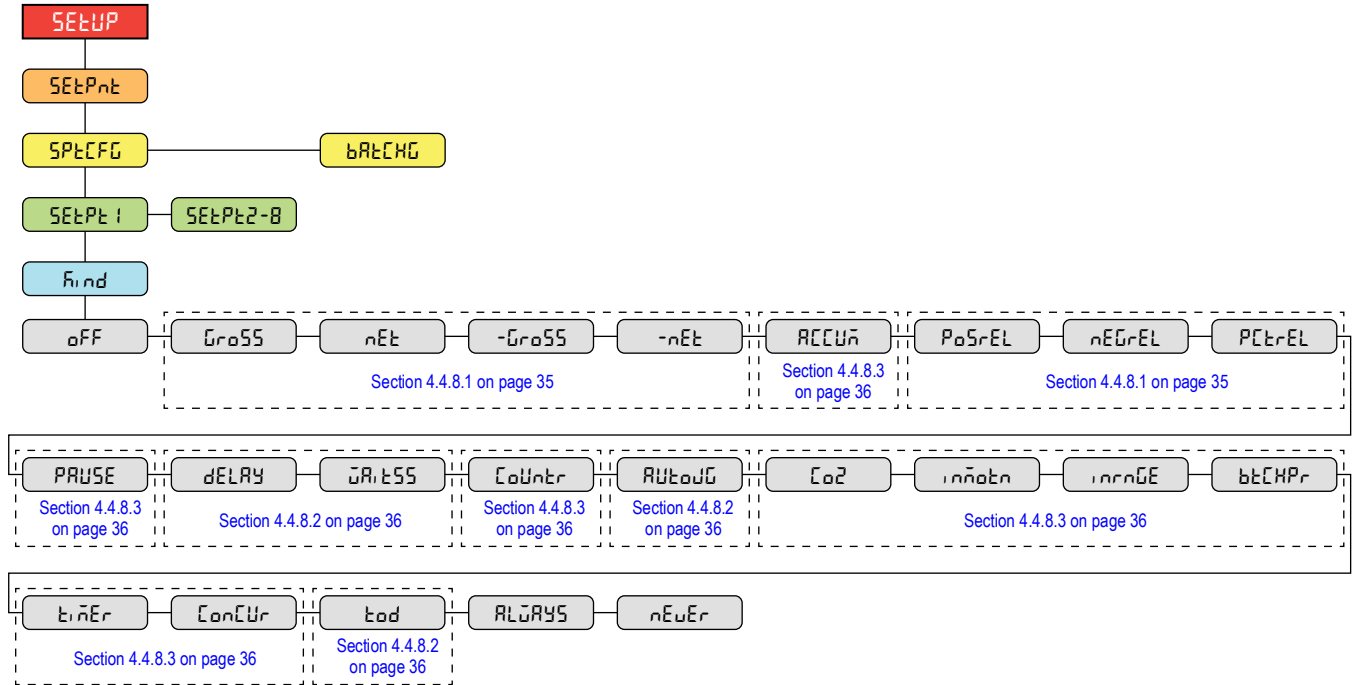

Figure 4-17. Setup – Setpoints Menu

Parameter	Description
SPtCFG	Setpoint Configuration – Access to configuration parameters and settings for up to eight setpoints; <i>Settings: SETPT1-8</i>
Knd	Setpoint Kind: <i>Settings: OFF (default), GROSS, NET, -GROSS, -NET, ACCUM, POSREL, NEGREL, PCTREL, PAUSE, DELAY, WAITSS, COUNTR, AUTOJG, COZ, INMOTN, INRNGE, BTCHPR, TIMER, CONCUR, TOD, ALWAYS, NEVER</i>
bRtCHG	Batching – Batch sequence runs when set to AUTO or MANUAL; <i>Settings: OFF (default)</i> <i>AUTO – Allows the batch sequence to repeat automatically once it has been started</i> <i>MANUAL – Requires a BATSTR input/command to run the batch sequence</i>

Table 4-16. Setup – Setpoints Menu Parameters

4.4.8.1 If KIND = GROSS, NET, -GROSS, -NET, POSREL, NEGREL, PCTREL

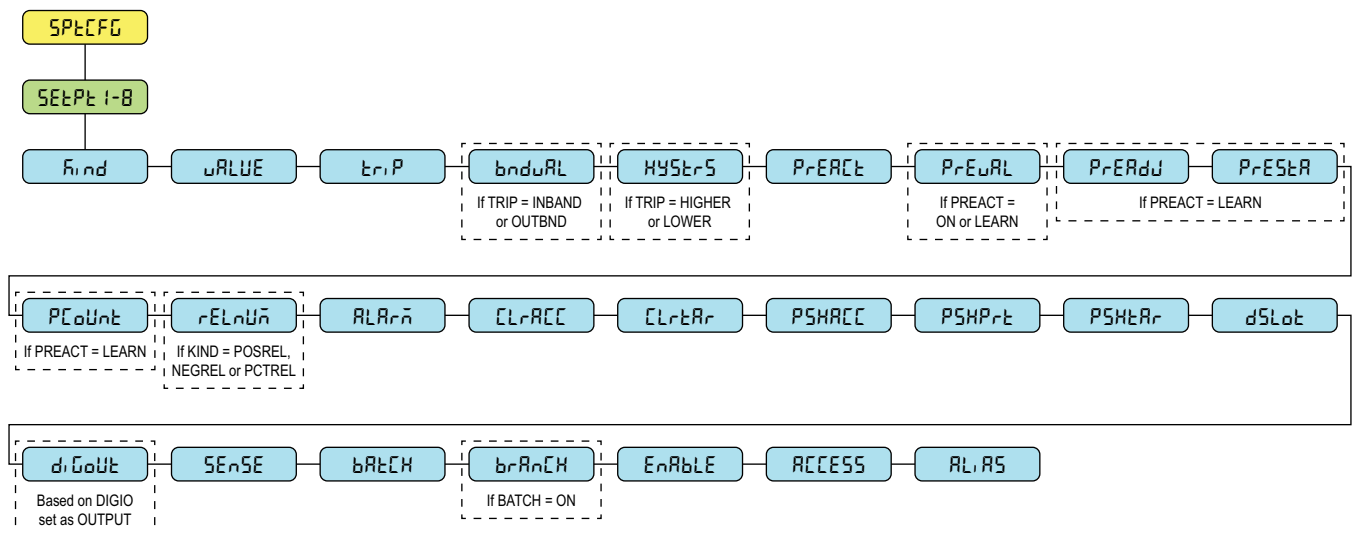

Figure 4-18. Setpoints – Parameter Group A

4.4.8.2 If KIND = ACCUM, DELAY, WAITSS, AUTOJG, TOD

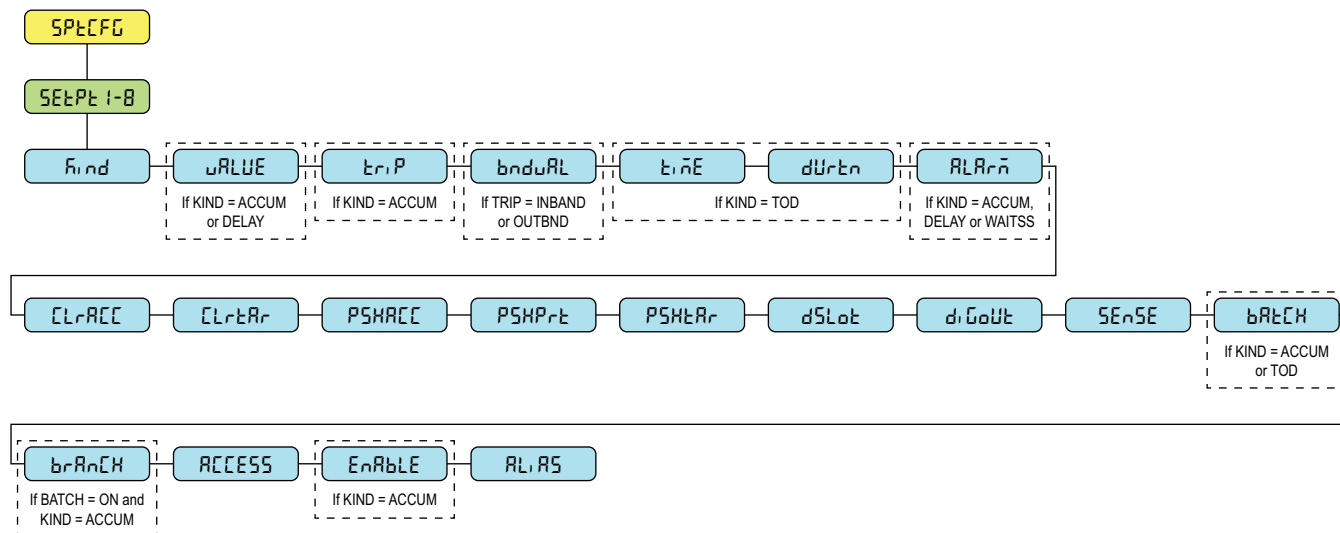

Figure 4-19. Setpoints – Parameter Group B

4.4.8.3 If KIND = PAUSE, COUNTR, COZ, INMOTN, INRNGE, BATCHPR, TIMER, CONCUR

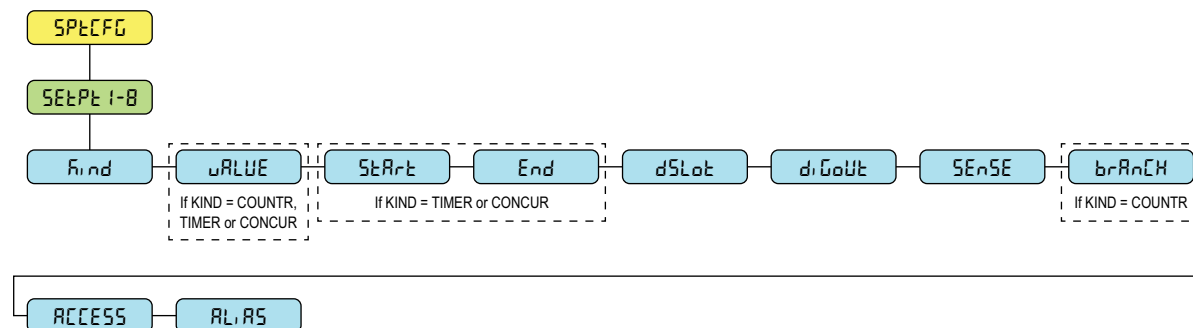

Figure 4-20. Setpoints – Parameter Group C

Parameter	Description
uRLUE	Setpoint Value – For weight-based setpoints: Enter value: 0.0–99999.0, 0.0 (default) For time-based setpoints: Enter value: 0.0–65535.0, 0.0 (default) For COUNTR setpoints: Enter value: 0.0–65535.0, 0.0 (default)
tRIP	Trip – Specifies whether the setpoint is satisfied when the weight is higher or lower than the setpoint value, within a band established around the value, or outside of the band; in a batch sequence with TRIP=HIGHER, the associated digital output is active until the setpoint value is reached or exceeded; with TRIP=LOWER, the output is active until the weight goes below the setpoint value; Settings: HIGHER (default), LOWER , INBAND , OUTBND
bnduRL	Band Value – For setpoints with TRIP=INBAND or OUTBND, specifies a weight equal to half the band width; The band established around the setpoint value is VALUE ±BNDVAL; Enter value: 0.0–99999.0, 0.0 (default)
HYSterS	Hysteresis – Specifies a band around the setpoint value which must be exceeded before the setpoint, once off, can trip on again; Enter value: 0.0–99999.0, 0.0 (default)
PrERREt	Preact Type – Allows the digital output associated with a setpoint to shut off before the setpoint is satisfied to allow for material in suspension; Settings: OFF (default) <i>ON</i> – Adjusts setpoint trip value up or down (depending on the TRIP parameter setting) from setpoint value using a fixed value specified on the PREVAL parameter <i>LEARN</i> – Can be used to automatically adjust the PRACT value after each batch; it compares the actual weight at standstill to the target setpoint value and adjusts the PREVAL by the PREADJ value times the difference after each batch

Table 4-17. Kind Parameter Descriptions

Parameter	Description
StArT	Starting Setpoint – Specifies starting setpoint number; do not specify number of the TIMER or CONCUR setpoint itself; TIMER or CONCUR setpoint begins when starting setpoint begins; <i>Enter value: 1–8, 1 (default)</i>
End	Ending Setpoint – Specifies ending setpoint number; do not specify number of the TIMER or CONCUR setpoint itself; TIMER or CONCUR setpoint stops when ending setpoint begins; <i>Enter value: 1–8, 1 (default)</i>
tiME	Time – For TOD setpoints, specifies the time at which the setpoint becomes active; the format used to enter the time (12hour or 24hour) is based on the value specified for the TIMFMT parameter in the Program menu (HHMM); <i>Enter value: 0000 (default)</i>
dURAtion	Duration – For TOD setpoints; specifies the length of time the digital output associated with this setpoint changes state; value is entered in hours, minutes, and seconds (HHMMSS); <i>Enter value: 000000 (default)</i>
PREVAL	Preact Value – Specifies the preact value for setpoints with PRACT set to ON or LEARN; depending on the TRIP setting specified for the setpoint, the setpoint trip value is adjusted up or down by the PREVAL value; <i>Enter value: 0.0–99999.0, 0.0 (default)</i>
PREAdj	Preact Adjustment – Setpoints with PRACT set to LEARN, specifies a decimal representation of the percentage of error correction applied (50.0 = 50%, 100.0 = 100%) each time a PRACT adjustment is made; <i>Enter value: 0.0–100.0, 50.0 (default)</i>
PREStE	Preact Stabilization Time-Out – Setpoints with PRACT set to LEARN, specifies the time, in 0.1-sec intervals, to wait for standstill before adjusting the PRACT value; setting this parameter to a value greater than zero disables the learn process if standstill is not achieved in the specified interval (in tenths of a second); <i>Enter value: 0–65535, 0 (default)</i>
PREInt	Preact Learn Interval Count – Setpoints with PRACT set to LEARN, specifies the number of batches after which the preact value is recalculated; the default value, 1, recalculates the preact value after every batch cycle; <i>Enter value: 1–65535, 1 (default)</i>
RELn	Relative Number – For relative setpoints, specifies the number of the relative setpoint; <i>Enter value: 1–8, 1 (default)</i> Target weight for this setpoint is determined as follows: POSREL setpoints, the value of the relative setpoint plus the value (VALUE parameter) of the POSREL setpoint NEGREL setpoints, the value of the relative setpoint minus the value of the NEGREL setpoint PCTREL setpoints, the percentage (specified on VALUE parameter of the PCTREL setpoint) of the target value of the relative setpoint
ALARM	Alarm – Specify ON to display the word ALARM on the primary display while the setpoint is active (batch setpoints) or while the setpoint is not tripped (continuous setpoints); <i>Settings: OFF (default), ON</i>
CLRACC	Clear Accumulator – Specify ON to clear the accumulator when the setpoint is satisfied; <i>Settings: OFF (default), ON</i>
CLRTAR	Clear Tare – Specify ON to clear the tare when the setpoint is satisfied; <i>Settings: OFF (default), ON</i>
PUSHACC	Push Accumulator – Specify ON to update the accumulator and perform a print operation when the setpoint is satisfied; specify ONQUIET to update the accumulator without printing; <i>Settings: OFF (default), ON, ONQUIET</i>
PUSHPR	Push Print – Specify ON to perform a print operation when the setpoint is satisfied; specify WAITSS to wait for standstill after setpoint is satisfied before printing; <i>Settings: OFF (default), ON, WAITSS</i>
PUSHTAR	Push Tare – Specify ON to perform an acquire tare operation when the setpoint is satisfied; <i>Settings: OFF (default), ON</i> NOTE: PSHTAR acquires the tare regardless of the value specified for the REGULA parameter in the Program menu
DIGOut	Digital Output Slot – Lists all available digital I/O slots; this parameter specifies the slot number of the digital I/O card referenced by the DIGOUT parameter; <i>Settings: NONE (default), 0</i>
DIGbit	Digital Output – Lists all digital output bit numbers available for the specified digital output slot; this parameter is used to specify the digital output bit associated with this setpoint; use the DIGIO menu to assign bit function to OUTPUT; <i>Enter value: 1–4, 1 (default)</i> NOTE: For continuous setpoints, the digital output becomes active (low) when the condition is met; for batch setpoints, the digital output is active until the setpoint condition is met
SENSE	Sense – Specifies whether the value of the digital output associated with this setpoint is inverted when the setpoint is satisfied; <i>Settings: NORMAL (default), INVERT</i>
BATCH	Batch – Specifies whether the setpoint is used as a batch (ON) or continuous (OFF) setpoint; <i>Settings: OFF (default), ON</i>
BRnCH	Branch Destination – Specifies the setpoint number to which the batch sequence is to branch, if the current setpoint is not satisfied upon initial evaluation (0 = do not branch); <i>Enter value: 0–8, 0 (default)</i>
ENABLE	Enable – Specifies if setpoint parameters display in user mode; <i>Settings: ON (default), OFF</i>
ACCESS	Access – Specifies the access allowed to setpoint parameters in user mode; <i>Settings:</i> ON (default) – Values can be displayed and changed HIDE – Values cannot be displayed or changed OFF – Values can be displayed but not changed
ALIAS	Alias – Name for the setpoint; <i>Enter characters: Alphanumeric entry up to 8 characters, SETPT (default)</i>

Table 4-17. Kind Parameter Descriptions (Continued)

4.4.9 Setup – Digital I/O Menu

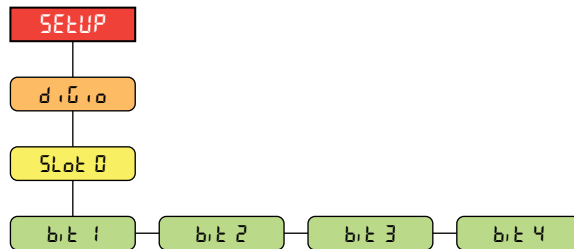

Figure 4-21. Setup – Digital I/O Menu

Parameter	Description
bit 1-4	Digital I/O Bit 1-4 – Specifies the mode and function of the digital I/O pins; Settings: OFF (default), PRINT, ZERO, TARE, UNITS, PRIM, SEC, CLEAR, DSPACC, DSPTAR, CLRACC, CLRTAR, NT/GRS, GROSS, NET, CLRCN, KBDLOC, BATRUN, BATSTR, BATPAS, BATRST, BATSTP, OUTPUT

Table 4-18. Setup – Digital I/O Menu Parameters

4.4.10 Setup – Analog Output Menu

Instructions to install and setup the analog output option card are provided with the option card kit (PN 195084).

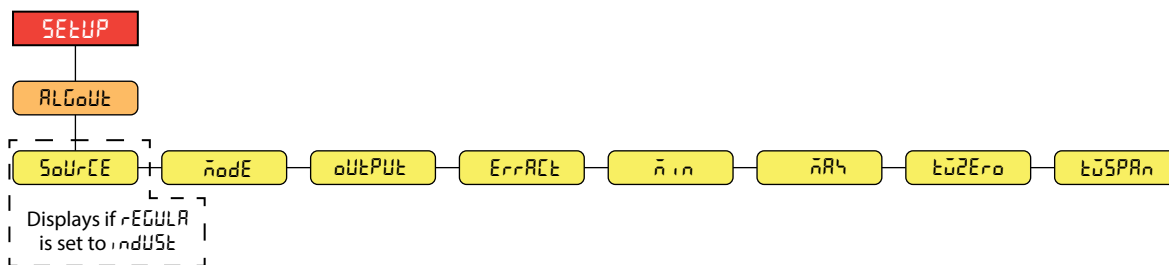

Figure 4-22. Setup – Analog Output Menu

Parameter	Description
SOURCE	Source – Specifies the scale tracked by the analog output; only appears if the Regulatory Mode (REGULA) parameter is set to Industrial (INDUST); Settings: SCALE 1 (default), REMOTE (Only available in Industrial Mode)
MODE	Mode – Specifies the weight data, gross or net, tracked by the analog output when the Source parameter is assigned to a scale; Settings: GROSS (default), NET
OUTPUT	Output – Specifies the voltage or current tracked by the analog output; Settings: 0-10V (default), 0-20MA, 4-20MA
ERRACT	Error Action – Specifies how the analog output responds to system error conditions; Settings: FULLSC (default) – Set to full scale (10 V or 20 mA) HOLD – Holds current value ZEROSC – Sets to zero value (0 V, 0 mA or 4 mA)
MIN	Minimum Weight – Specifies the minimum weight value tracked by the analog output; Enter value: ±999999.0, 0.0 (default)
MAX	Maximum Weight – Specifies the maximum weight value tracked by the analog output; Enter value: ±999999.0, 10000.0 (default)
TWEZERO	Tweak Zero – Adjusts the offset of the analog output zero value; Enter value: 0-65535, 0 (default)
TWESPAN	Tweak Span – Adjusts the offset of the analog output span value; Enter value: 0-65535, 59515 (default)

Table 4-19. Setup – Analog Output Menu Parameters

4.5 Accumulator Menu

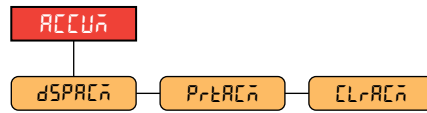

Figure 4-23. Accumulator Menu

Parameter	Description
dSPACn	Display Accumulator – Displays the accumulator value; <i>Read Only</i>
PrtACn	Print Accumulator – Prints the accumulator value using the ACCFMT to specified port, if configured
CLrACn	Clear Accumulator – Clears the accumulator value

Table 4-20. Accumulator Menu Parameters

4.6 Tare Menu

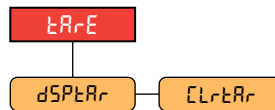

Figure 4-24. Tare Menu

Parameter	Description
dSPtRr	Display Tare – Displays the current tare value; <i>Read Only</i>
CLrTrr	Clear Tare – Clears the current tare value

Table 4-21. Tare Menu Parameters

5.0 Calibration

The 680HE can be calibrated using the front panel and EDP commands. The following sections describe the procedures required for both of these calibration methods.



NOTE: The 680HE requires a WZERO and WSPAN points to be calibrated. The linear calibration points are optional; they must fall between zero and span, but must not duplicate zero or span.

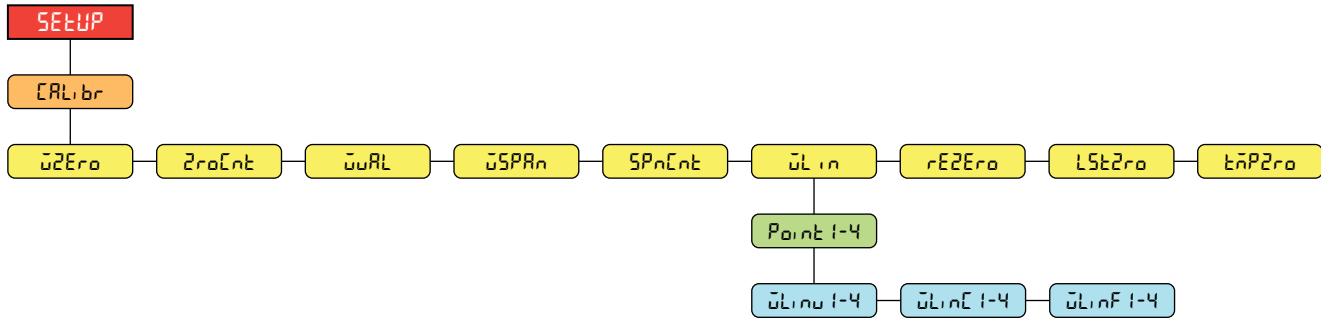

Figure 5-1. Calibration Menu

5.1 Front Panel Calibration

5.1.1 Span Calibration

Use the following steps to perform a standard span calibration on a connected scale.

1. Access the setup menu via the setup jumper (Section 4.1 on page 21). `CONF` displays.
2. Press **PRINT** twice. `CALibr` displays.
3. Press **GROSS NET B/W**. `uZERO` displays.



NOTE: See Section 5.2 on page 41 if the application requires a rezero, last zero or temporary zero.

4. Ensure there is no weight on the scale.
5. Press **TARE** to perform a zero calibration. `oH` displays.
6. Press **TARE**. `ZEROnt` displays. See Section 4.4.3 on page 25 for more information on `ZEROnt`.
7. Press **PRINT**. `uARL` displays.
8. Press **GROSS NET B/W**. The current test weight value displays.
9. Press **CLEAR** and use the numeric keypad to enter a new value, if necessary.
10. Press **TARE** to accept value. `uSPRn` displays.
11. Place the specified amount of test weight on the scale.
12. Press **TARE** to perform a span calibration. `oH` displays.
13. Press **TARE**. `SPnCnt` displays. See Section 4.4.3 on page 25 for more information on `SPnCnt`.













NOTE: Span calibration is complete. To continue with a linear calibration, see Section 5.1.2 on page 41 before returning to weigh mode.

14. Press **MENU** to return to weigh mode.

5.1.2 Linear Calibration

Linear calibration points provide increased scale accuracy by calibrating the indicator at up to four additional points between the zero and span calibrations.

1. Complete [steps 1–13](#) in [Section 5.1.1 on page 40](#). Press . $\bar{w}L_n$ displays.
2. Press . $P_{01}n1$ displays.
3. Press . $\bar{w}L_{n1}$ displays.
4. Press . The current test weight value for point 1 displays.
5. Press  and use the numeric keypad to enter a new value, if necessary.
6. Press  to accept value. $\bar{w}L_{n1}$ displays.
7. Place the specified amount of test weight on the scale.
8. Press  to perform a linear point calibration. $\bar{w}L_{n1}$ displays.
9. Press . $\bar{w}L_{n1}$ displays. See [Section 4.4.3 on page 25](#) for more information on WLINF#.
10. Press . $P_{01}n1$ displays.
11. Press . $P_{01}n2$ displays.
12. Repeat previous steps for points 2-4, if necessary.



NOTE: *The linear calibration for a point is saved once point is calibrated.*

13. Press  to return to weigh mode.

5.2 Alternative Zero Calibrations

During a calibration, the zero value ($\bar{w}ZEr_0$) can be replaced with a temporary zero ($\bar{w}ZPZr_0$) or last zero ($\bar{w}ZLZr_0$). A rezero ($\bar{w}ZEZr_0$) can be done after calibration. See below for information on these alternative zeros.

5.2.1 Last Zero

This takes the last push-button zero in the system (from weigh mode) and uses it as the new zero reference point, after which a new span calibration must be performed. This calibration cannot be performed when calibrating a scale for the first time.

A last zero calibration is typically used on truck scales to allow a scale verification to become a calibration without having to remove the test weights.

5.2.2 Temporary Zero

A temporary zero calibration temporarily zeros the displayed weight of a non-empty scale. After span calibration, the difference between the temporary zero and the previously calibrated zero value is used as an offset.

A temporary zero calibration is typically used on hopper scales to calibrate the span without losing the original zero calibration.

5.2.3 Rezero

A rezero calibration is needed to remove a calibration offset when hooks or chains are required to suspend the test weights.

Once a span calibration is complete, remove the hooks or chains and the test weights from the scale. With all the weight removed, a rezero calibration is used to adjust the zero and span calibration values.

5.3 EDP Command Calibration

Use the following instructions to calibrate the 680HE using EDP commands. For information on the EDP commands of the 680HE, see [Section 7.0 on page 44](#).



NOTE: *The indicator must respond with OK after each step or the calibration procedure must be done again.*

1. Place indicator into setup mode via the setup jumper ([Section 4.1 on page 21](#)).
2. For a standard calibration, remove all weight from scale (except hooks or chains which are needed to attach weights).
3. Send the command **SC.WZERO#1** to perform a standard calibration of the zero point.
 - Send **SC.TEMPZERO#1** to perform a temporary zero calibration
 - Send **SC.LASTZERO#1** to perform a last zero calibration
4. Apply the span calibration weight to the scale.
5. Send the command **SC.WVAL#1=xxxxx**, where **xxxxx** is the exact value of the span calibration weight applied to the scale.
6. Send the command **SC.WSPAN#1** to calibrate the span point. Continue on to [step 7](#) to calibrate additional linearization points, or proceed to [step 11](#).
7. Apply weight equal to the first linearization point to the scale.
8. Send the command **SC.WLIN#n#1=xxxxx**, where **n** is the linearization point number (1-4) and **xxxxx** is the exact value of the weight applied.
9. Send the command **SC.WLIN.Cn#1** to calibrate the linearization point.
10. Repeat [steps 7–9](#) for up to four total linearization points.
11. If hooks or chains were used to attach the weights, remove all weight, including the hooks and chains, and send the command **SC.REZERO#1** to remove the zero offset.
12. Send the command **KSAVEEXIT** to return to weigh mode.

6.0 Revolution

The Revolution utility provides a suite of functions used to support configuration, calibration, customization and backup of the 680HE configuration.

Calibration values and scale configuration can both be saved and restored to the 680HE using Revolution.



NOTE: For system requirements visit the Revolution product page on [Rice Lake Weighing Systems website](#).

6.1 Connecting to the Indicator

Connect the PC serial port to com 1 of the 680HE, then click **Connect** in the toolbar. Revolution attempts to establish communications to the indicator. If communications settings need to be adjusted, select **Options...** from the Tools menu.

Downloading to the Indicator

The **Send Configuration to Device** function in the Revolution Communications menu allows a Revolution configuration file (with or without scale calibration data) or ticket formats to be downloaded to a connected indicator in setup mode.

The **Send Section to Device** function on the Communications menu allows the download of only the currently displayed object, such as a scale configuration.

Because less data is transferred using the **Send Section to Device**, it is typically faster than a full configuration download, but there is an increased possibility the download fails due to dependencies on other objects. If the download fails, try performing a complete download using the **Send Configuration to Device** function.

Uploading Configuration to Revolution

The **Get Configuration from Device** function in the Revolution Communications menu allows the existing configuration of a connected indicator to be saved to a file on the PC. Once saved, the configuration file provides a backup which can be quickly restored to the indicator if needed. Alternatively, the file can be edited within Revolution and downloaded back to the indicator.

6.2 Saving and Transferring Data



NOTE: Revolution has a module to save and transfer data. It is the preferred method over using ProComm or Hyper Terminal.

6.2.1 Saving Indicator Data to a Personal Computer

Configuration data can be saved to a computer connected to the selected port. The PC must be running a communications program such as PROCOMMPLUS®.

When configuring the indicator, ensure the values set for the baud and bits parameters on the serial menu match the baud rate, bits and parity settings configured for the serial port on the PC.

To save all configuration data, first put the communications program into data capture mode, then place the indicator in setup mode and send the DUMPALL command to the indicator. The 680HE responds by sending all configuration parameters to the PC as ASCII-formatted text.

6.2.2 Downloading Configuration Data from PC to Indicator

Configuration data saved on a PC or disc can be downloaded from the PC to an indicator. This procedure is useful when a number of indicators with similar configurations are set up or when an indicator is replaced.

To download configuration data, connect the PC to the selected port as described in [Section 6.2.1](#). Place the indicator in setup mode and use the PC communications software to send the saved configuration data to the indicator. When transfer is complete, calibrate the indicator as described in [Section 5.0 on page 40](#).

6.3 Updating Firmware

Revolution is used to update the firmware of the 680HE indicator. The link to begin this process is available on the Revolution home screen. Updating the firmware defaults configuration settings.

7.0 EDP Commands

The 680HE indicator can be controlled by a personal computer connected to one of the indicator communication ports. Control is provided by a set of commands which can simulate front panel key press functions, return and change setup parameters, and perform reporting functions. The commands provide the capability to print configuration data or to save data to an attached personal computer. This section describes the EDP command set and procedures for saving and transferring data using the communication ports. The EDP command set is divided into several groups.

When the indicator processes a command, it either responds with a value (for reporting commands, or when querying parameter settings), or with the message **OK**. The **OK** response verifies the command was received and has been executed. If the command is unrecognized, the indicator responds with **?? invalid command**. If the command cannot be executed in the current mode, the indicator responds with **?? invalid mode**. If the command is recognized, but the value is out of range or the invalid type, the indicator responds with **??** followed by the type and the range.

7.1 Key Press Commands

Key press serial commands simulate pressing keys on the front panel of the indicator. These commands can be used in both setup and weigh mode. Several of the commands serve as pseudo keys, providing functions which are not represented by a key on the front panel.

For example, to enter a 15 lb tare weight using serial commands:

1. Type **K1** and press **Enter** (or **Return**).
2. Type **K5** and press **Enter**.
3. Type **KTARE** and press **Enter**.

Command	Function
KZERO	In weigh mode, this command acts like pressing the Zero key
KGROSSNET	In weigh mode, this command acts like pressing the Gross/Net key
KGROSS	Displays Gross mode (pseudo key)
KNET	Displays Net mode (pseudo key)
KTARE	In weigh mode, this command acts like pressing the Tare key
KUNITS	In weigh mode, this command acts like pressing the Units key
KMENU	This command acts like pressing the Menu key
KPRIM	Displays primary units (pseudo key)
KSEC	Displays secondary units (pseudo key)
KPRINT	In weigh mode, this command acts like pressing the Print key
KPRINTACCUM	Prints the accumulated weight
KDISPACCUM	Displays the accumulator value
KDISPTARE	Displays the tare value
KCLR	In weigh mode, this command acts like pressing the Clear key
KCLRRCN	Clears consecutive number
KCLRTAR	Clears the tare from the system (pseudo key)
KLEFT	In setup mode, this command moves Left in the menu
KRIGHT	In setup mode, this command moves Right in the menu
KUP	In setup mode, this command moves Up in the menu
KDOWN	In setup mode, this command moves Down in the menu
KEXIT	In setup mode, this command exits to weigh mode
KSAVE	In setup mode, this command saves the current configuration
KSAVEEXIT	In setup mode, this command saves the current configuration and exits to weigh mode
KTIME	Returns time
KDATE	Returns date
KTIMEDATE	Returns time and date

Table 7-1. Key Press Commands

Command	Function
KCLRACCUM	Clears the accumulator
Kn	This command acts like pressing numbers 0 (zero) through 9
KDOT	This command acts like pressing the decimal point (.)
KENTER	This command acts like pressing the Enter key
KYBDLK	In setup mode, this command locks the keys, except for the Menu key
KLOCK=x	In setup mode, this command locks specified front panel key; x = KPRINT, KUNITS, KTARE, KGROSSNET, KZERO, K0-K9, KDOT, KCLEAR (example: to lock the Zero key, enter KLOCK=KZERO)
KUNLOCK=x	In setup mode, this command unlocks specified front panel key; x = KPRINT, KUNITS, KTARE, KGROSSNET, KZERO, K0-K9, KDOT, KCLEAR (example: to unlock the Print key, enter KUNLOCK=KPRINT)

Table 7-1. Key Press Commands (Continued)

7.2 Reporting Commands

Reporting commands send specific information to the communications port. The commands listed in Table 7-2 can be used in either setup mode or weigh mode.

Command	Function
DUMPALL	Returns a list of all parameter values
DUMPAUDIT	Returns the Audit Trail information
KDUMPAUDIT	Returns the Audit Trail information on the same port which the EDP command was sent
AUDIT.LRVERSION	Returns the legally relevant firmware version
AUDIT.CONFIG	Returns the number of times configuration has changed
AUDIT.CALIBRATE	Returns the number of calibrations
AUDITJUMPER	Returns the position of the audit jumper (ON or OFF)
SPDUMP	Returns a list of the setpoint parameter values
VERSION	Returns the firmware version
HARDWARE	Returns the option card installed
HWSUPPORT	Returns the CPU board part number
RTCBATTERYSTATUS	Returns the status of the real time clock battery (GOOD or BAD)

Table 7-2. Reporting Commands

7.3 Reset Configuration Command

The following command can be used to reset the configuration parameters of the 680HE.

Command	Function
RESETCONFIGURATION	Restores all configuration parameters to default values (setup mode only)

Table 7-3. Reset Configuration Command



NOTE: All scale calibration settings are lost when the **RESETCONFIGURATION** command is run.

7.4 Parameter Setting Commands

Parameter setting commands allow the current value for a configuration parameter to be displayed or changed. Current configuration parameter settings can be displayed in setup mode or weigh mode using the following syntax:
command<ENTER>

Most parameter values can be changed in setup mode only; setpoint parameters listed in [Table 7-10 on page 50](#) can be changed when in normal weigh mode.



NOTE: The user must stop the current batch for new values to take effect.

Use the following command syntax when changing parameter values: command=value<ENTER>, where **value** is either a number or a parameter value. Use no spaces before or after the equal (=) sign. If an incorrect command is typed or an invalid value is specified, the indicator returns ?? followed by the error message.

Example: to set the motion band parameter on Scale #1 to 5 divisions, type the following:

SC.MOTBAND#1=5<ENTER>

To return a list of the available values for parameters with specific values, enter the command and equal sign, followed by a question mark (command=?<ENTER>). The indicator must be in setup mode to use this function.

After changes are made to configuration parameters using EDP commands, use the **KSAVE** or **KSAVEEXIT** commands to commit the changes to memory.

Command	Description	Values
SC.CAPACITY#n	Scale capacity	0.00001–99999.0, 10000.0 (default)
SC.ZTRKBD#n	Zero track band (in display divisions)	0.0–100.0, 0.0 (default)
SC.ZRANGE#n	Zero range (%)	0.0–100.0, 1.9 (default)
SC.MOTBAND#n	Motion band (in display divisions)	0–100, 1 (default)
SC.SSTIME#n	Standstill time (in 0.1 second intervals; 10 = 1 second)	0–600, 10 (default)
SC.SENSE#n	Specifies type of load cell cable connection into J1	4-WIRE (default), 6-WIRE
SC.OVERLOAD#n	Overload	FS+2% (default), FS+1D, FS+9D, FS
SC.WMTTHR#n	Weighment threshold	0.0–99999.0, 1000.0 (default)
SC.NUMWEIGH#n	Number of weighments (Read Only)	0–4294967295, 0 (default)
SC.MAX_WEIGHT#n	Maximum weight (Read Only)	-999999–999999, 0 (default)
SC.MAX_DATE#n	Date of maximum weight (Read Only)	Up to 25 alphanumeric characters
SC.DIGFLTR1#n SC.DIGFLTR2#n SC.DIGFLTR3#n	Number of A/D samples averaged for the individual stages (1-3) of the three stage digital filter	1, 2, 4 (default), 8, 16, 32, 64, 128, 256
SC.DFSENS#n	Digital filter cutout sensitivity	2OUT (default), 4OUT, 8OUT, 16OUT, 32OUT, 64OUT, 128OUT
SC.DFTHR#n	Digital filter cutout threshold	NONE (default), 2D, 5D, 10D, 20D, 50D, 100D, 200D, 250D
SC.RATLTRAP#n	Rattletrap filtering	OFF (default), ON
SC.SMPRAT#n	Scale A/D sample rate	6.25HZ, 7.5HZ, 12.5HZ, 15HZ, 25HZ, 30HZ (default), 50HZ, 60HZ, 100HZ, 120HZ
SC.PWRUPMD#n	Power up mode	GO (default), DELAY
SC.TAREFN#n	Tare function	BOTH (default), KEYED, NOTARE, PBTARE
SC.PRI.FMT#n	Primary units format (decimal point and display divisions)	888100, 888200, 888500, 888810, 888820, 888850, 888881 (default), 888882, 888885, 88888.1, 88888.2, 88888.5, 8888.81, 8888.82, 8888.85, 888.881, 888.882, 888.885, 88.8881, 88.8882, 88.8885
SC.PRI.UNITS#n	Primary units	LB (default), KG, OZ, TN, T, G, NONE
SC.SEC.FMT#n	Secondary units format (decimal point and display divisions)	888100, 888200, 888500, 888810, 888820, 888850, 888881, 888882, 888885, 88888.1, 88888.2, 88888.5 (default), 8888.81, 8888.82, 8888.85, 888.881, 888.882, 888.885, 88.8881, 88.8882, 88.8885
SC.SEC.UNITS#n	Secondary units	LB, KG (default), OZ, TN, T, G, NONE

For commands ending with #n, n is the scale number (1)

Table 7-4. Parameter Setting Commands

Command	Description	Values
SC.SEC.ENABLED#n	Enable the Secondary Units	ON (default), OFF
SC.FILTERCHAIN#n	Defines what filter to use	AVGONLY (default), ADPONLY, DMPONLY, RAW
SC.DAMPINGVALUE#n	Sets the damping time constant	1–2560 (in 0.1 second intervals), 10 (default)
SC.ADTHRESHOLD#n	Adaptive filter weight threshold value	0–2000 (in display divisions), 10 (default)
SC.ADSENSITIVITY#n	Adaptive filter sensitivity	LIGHT (default), MEDIUM, HEAVY
SC.ACCUM#n	Accumulator enable	OFF (default), ON
SC.WZERO#n	Perform zero calibration	—
SC.TEMPZERO#n	Perform temporary zero calibration	—
SC.LASTZERO#n	Perform last zero calibration	—
SC.WVAL#n	Test weight value	0.00001–999999.99999, 10000.0 (default)
SC.WSPAN#n	Perform span calibration	—
SC.WLIN.F1#n– SC.WLIN.F4#n	Actual raw count value for linearization points 1–4	0–16777215, 0 (default)
SC.WLIN.V1#n– SC.WLIN.V4#n	Test weight value for linearization points 1–4 (A setting of 0 indicates the linearization point is not used)	0.00001–999999.99999, 0.0 (default)
SC.WLIN.C1#n– SC.WLIN.C4#n	Perform linearization calibration on points 1–4	—
SC.LC.CD#n	Deadload coefficient raw count value	0–16777215, 8386509 (default)
SC.LC.CW#n	Span coefficient raw count value	0–16777215, 2186044 (default)
SC.LC.CZ#n	Temporary zero raw count value	0–16777215, 2186044 (default)
SC.REZERO#n	Perform the Rezero calibration function	—
SC.INITIALZERO#n	Initial Zero range in % of full scale	0.0–100.0, 0.0 (default)
SC.RTZGRAD#n	Number of graduations from the zero base at which the accumulator re-arms itself	0.0–100.0, 0.4 (default)
For commands ending with #n, n is the scale number (1)		

Table 7-4. Parameter Setting Commands (Continued)

7.5 EDP Setting Commands

Command	Description	Values
EDP.INPUT#p	Port serial input function	CMD (default), STRIND, STRLFT, REMOTE
EDP.BAUD#p	Port baud rate	1200, 2400, 4800, 9600 (default), 19200, 38400, 57600, 115200
EDP.BITS#p	Port data bits/parity	8NONE (default), 7EVEN, 7ODD, 8EVEN, 8ODD
EDP.TERMIN#p	Port line termination character	CR/LF (default), CR
EDP.STOPBITS#p	Port stop bits	1 (default), 2
EDP.ECHO#p	Port echo	ON (default), OFF
EDP.RESPONSE#p	Port response	ON (default), OFF
EDP.EOLDLY#p	Port end-of-line delay	0–255 (0.1-second intervals), 0 (default)
EDP.ADDRESS#p	Port RS-485 address (p = 3)	0–255, 0 (default)
EDP.DUPLEX#p	Port RS-485/422 FULL or HALF duplex (p = 3)	FULL (default), HALF
For commands ending with #p, p is the port number (1-3)		

Table 7-5. EDP Setting Commands

7.6 Ethernet and USB Setting Commands

Command	Description	Values
WIRED.MACID	Ethernet hardware MAC ID (read only)	xx:xx:xx:xx:xx:xx, 00:00:00:00:00:00 (default)
WIRED.DHCP	Enable Ethernet DHCP	ON (default), OFF
WIRED.ENABLED	Enable wired Ethernet adapter	ON, OFF (default)
WIRED.IPADDR	Ethernet IP address	Valid IP xxx.xxx.xxx.xxx*, 0.0.0.0 (default)
WIRED.SUBNET	Ethernet subnet mask	Valid IP xxx.xxx.xxx.xxx*, 255.255.255.0 (default)
WIRED.GATEWAY	Ethernet gateway	Valid IP xxx.xxx.xxx.xxx*, 0.0.0.0 (default)
TCPC1.ECHO	TCP Client 1 echo	ON (default), OFF
TCPC1.EOLDLY	TCP Client 1 end-of-line delay	0–255 (in 0.1 sec intervals), 0 (default)
TCPC1.IPADDR	TCP Client 1 remote server IP	Valid IP xxx.xxx.xxx.xxx*, 0.0.0.0 (default)
TCPC1.LINETERM	TCP Client 1 line termination	CR/LF (default), CR
TCPC1.PORT	TCP Client 1 remote server port	1025–65535, 10001 (default)
TCPC1.RESPONSE	TCP Client 1 response	ON (default), OFF
TCPC1.INPUT	TCP Client 1 input function	CMD (default), STRIND, STRLFT, REMOTE
TCPC1.DISCTIME	TCP Client 1 disconnect time (in seconds)	0–60 (0= do not disconnect), 0 (default)
TCPS.PORT	TCP Server port number	1025–65535, 10001 (default)
TCPS.HOSTNAME	TCP Server host name	Up to 30 alphanumeric characters, 0 (default)
TCPS.INPUT	TCP Server input type	CMD (default) STRIND, STRLFT, REMOTE
TCPS.ECHO	TCP Server echo	ON , OFF (default)
TCPS.LINETERM	TCP Server line termination	CR/LF (default), CR
TCPS.RESPONSE	TCP Server response	ON (default), OFF
USB.INPUT	USB input function	CMD (default), STRIND, STRLFT, REMOTE
USB.LINETERM	USB line terminator	CR/LF (default), CR
USB.ECHO	USB echo	ON (default), OFF
USB.RESPONSE	USB response	ON (default), OFF
USB.EOLDLY	USB end of line delay	0–255 (in 0.1 sec intervals), 0 (default)

* A valid IP consists of four numbers, in the range of 0 to 255, separated by a decimal point (127.0.0.1 and 192.165.0.230 are valid IP addresses)

Table 7-6. Internet Setting Commands

7.7 Stream Setting Commands

Command	Description	Values
STRM.FORMAT#n	Stream format	RLWS (default), CARDNAL, WTRONIX, TOLEDO, CUSTOM
STRM.CUSTOM#n	Custom stream definition	Up to 1000 alphanumeric characters
STRM.GROSS#n	Mode token when streaming the Gross weight	Up to 8 alphanumeric characters, G (default)
STRM.NET#n	Mode token when streaming the Net weight	Up to 8 alphanumeric characters, N (default)
STRM.PRI#n	Units token when streaming Primary units	Up to 8 alphanumeric characters, L (default)
STRM.SEC#n	Units token when streaming Secondary units	Up to 8 alphanumeric characters, K (default)
STRM.UNITS#n	Dynamic defaults to configured units of the scale; Static uses EDP set Primary/Secondary units token	DYNAMIC (default), STATIC
STRM.INVALID#n	Status token when streaming an Invalid weight	Up to 2 alphanumeric characters, I (default)
STRM.MOTION#n	Status token when the weight is in motion	Up to 2 alphanumeric characters, M (default)
STRM.POS#n	Polarity token when the weight is positive	SPACE (default), NONE, +
STRM.NEG#n	Polarity token when the weight is negative	SPACE, NONE, – (default)
STRM.OK#n	Status token when the weight is OK (not invalid, out of range, at zero, or in motion)	Up to 2 alphanumeric characters (default is a space)
STRM.TARE#n	Mode token when streaming the tare weight	Up to 8 alphanumeric characters, T (default)
STRM.RANGE#n	Status token when the weight is Out of Range	Up to 2 alphanumeric characters, O (default)
STRM.ZERO#n	Status token when the weight is at Center of Zero	Up to 2 alphanumeric characters, Z (default)

For commands ending with #n, n is the stream format number (1)

Table 7-7. Stream Setting Commands

7.8 Program Commands

Command	Description	Values
DATEFMT	Date format	MMDDYY (default), DDDMMYY, YYMMDD, YYDDMM
DATESEP	Date separator	SLASH (default), DASH, SEMI, DOT
TIMEFMT	Time format	12HOUR (default), 24HOUR
TIMESEP	Time separator	COLON (default), COMMA, DOT
CONSNUM	Consecutive numbering	0–999999, 0 (default)
CONSTUP	Consecutive number start-up value	0–999999, 0 (default)
UID	ID of the indicator	Up to 8 alphanumeric characters, 1 (default)
KYBDLK	Keyboard lock (disable keypad)	OFF (default), ON
ZERONLY	Disable all keys except ZERO	OFF (default), ON
CONTACT.COMPANY	Contact company name	Up to 30 alphanumeric characters
CONTACT.ADDR1-3	Contact company address	Up to 20 alphanumeric characters (for each line)
CONTACT.NAME1-3	Contact names	Up to 30 alphanumeric characters (for each line)
CONTACT.PHONE1-3	Contact phone numbers	Up to 20 alphanumeric characters (for each line)
CONTACT.EMAIL	Contact email address	Up to 40 alphanumeric characters
CONTACT.LASTCAL	Last calibration date	Date MMDDYYYY as an 8-digit number
CONTACT.NEXTCAL	Next calibration date	Date MMDDYYYY as an 8-digit number
KHOLDTIME	Key hold time (in tenths of a second); 20 equals 2 seconds	10–50, 20 (default)
KHOLDINTERVAL	Key hold time interval; the amount of time between increments during a key hold (in twentieths of a second); 2 equals a tenth of a second (10 increments per second during a key hold)	1–100, 2 (default)
COLOR	Sets the color of the LED display	RED (default), GREEN
BRIGHTNESS	Sets the brightness of the LED display	LOW (default), HIGH
LOCALE	Enable gravity compensation	OFF (default), ON, FACTOR
LAT.LOC	Origin latitude (to nearest degree) for gravity compensation	0–90, 45 (default)
ELEV.LOC	Origin elevation (in meters) for gravity compensation	-9999–9999, 345 (default)
DEST.LAT.LOC	Destination latitude (in degrees) for gravity compensation	0–90, 45 (default)
DEST.ELEV.LOC	Destination elevation (in meters) for gravity compensation	-9999–9999, 345 (default)
GRAV.LOC	Origin gravity factor (in m/s ²) for gravity compensation	9.00000–9.99999, 9.80665 (default)
DEST.GRAV.LOC	Destination gravity factor (in m/s ²) for gravity compensation	9.00000–9.99999, 9.80665 (default)
PERSISTENTTARE	Saves tare value of scale on power cycle	OFF (default), ON
REMOTE.PRINTDESTINATION	Determines which indicator in the local/remote setup performs the print action	REMOTE, LOCAL (default)

Table 7-8. Feature Commands

7.9 Regulatory Commands

Command	Description	Values
REGULAT	Regulatory mode	NTEP (default), CANADA, INDUST, NONE, OIML
AUDAGNCY	Audit Agency (Industrial Mode)	NTEP (default), CANADA, NONE, OIML
REG.SNPSHOT	Display or Scale weight source	DISPLAY (default), SCALE
REG.HTARE	Allow tare in display hold	NO (default), YES
REG.ZTARE	Remove tare on ZERO	NO (default), YES
REG.KTARE	Always allow keyed tare	NO, YES (default)
REG.MTARE	Multiple tare action	REPLACE (default), REMOVE, NOTHING
REG.NTARE	Allow negative tare	NO (default), YES
REG.CTARE	Allow Clear key to clear tare/accumulator	NO, YES (default)
REG.NEGTOTAL	Allow total scale to display negative value	NO (default), YES
REG.PRTMOT	Allow print while in motion	NO (default), YES
REG.PRINTPT	Add PT to keyed tare print	NO, YES (default)

NTEP defaults shown for regulatory command values

Table 7-9. Regulatory Commands

Command	Description	Values
REG.PRTHLD	Print during display hold	NO (default), YES
REG.HLDWGH	Allow weighment during display hold	NO (default), YES
REG.MOTWGH	Allow weighment in motion	NO (default), YES
REG.OVRBASE	Zero base for overload calculation	CALIB (default), SCALE
REGWORD	Regulatory word	GROSS (default), BRUTTO
REG.RTARE	Round the Pushbutton Tare	NO, YES (default)
REG.RKTARE	Round the Keyed Tare	NO, YES (default)
REG.AZTNET	Perform AZT on Net value	NO (default), YES
REG.MANUALCLEARARE	Allows manual clearing of the tare value	NO, YES (default)
REG.TAREINMOTION	Allows Tare in Motion	NO (default), YES
REG.ZEROINMOTION	Allows scale to be zeroed while in motion	NO (default), YES
REG.UNDERLOAD	Underload weight value in display divisions	1-999999, 20 (default)

NTEP defaults shown for regulatory command values

Table 7-9. Regulatory Commands (Continued)

7.10 Setpoint Commands

Command	Description	Values
BATCHNG	Batching mode	OFF (default), AUTO, MANUAL
SP.KIND#n	Setpoint kind	OFF (default), GROSS, NET, -GROSS, -NET, ACCUM, POSREL, NEGREL, PCTREL, PAUSE, DELAY, WAITSS, COUNTER, AUTOJOG, COZ, INMOTON, INRANGE, BATCHPR, TIMER, CONCUR, TOD, ALWAYS, NEVER
SP.VALUE#n	Setpoint value	0.0-99999.0, 0.0 (default)
SP.TRIP#n	Trip	HIGHER (default), LOWER, INBAND, OUTBAND
SP.BANDVAL#n	Band value	0.0-99999.0, 0.0 (default)
SP.HYSTER#n	Hysteresis	0.0-99999.0, 0.0 (default)
SP.PREACT#n	Preact type	OFF (default), ON, LEARN
SP.PREVAL#n	Preact value	0.0-99999.0, 0.0 (default)
SP.PREADJ#n	Preact adjustment percentage	0.0-100.0, 50.0 (default)
SP.PRESTAB#n	Preact learn stability (in tenths of a second)	0-65535, 0 (default)
SP.PCOUNT#n	Preact learn interval	1-65535, 1 (default)
SP.BATCH#n	Batch step enable	OFF (default), ON
SP.CLRACCM#n	Clear accumulator enable	OFF (default), ON
SP.CLRTARE#n	Clear tare enable	OFF (default), ON
SP.PSHACCM#n	Push accumulate	OFF (default), ON, ONQUIET
SP.PSHPRINT#n	Push print	OFF (default), ON, WAITSS
SP.PSHTARE#n	Push tare	OFF (default), ON
SP.ALARM#n	Alarm enable	OFF (default), ON
SP.ALIAS#n	Setpoint name	Up to 8 alphanumeric characters, SETPT (default)
SP.ACCESS#n	Setpoint access	OFF, ON (default), HIDE
SP.DSLOT#n	Digital output slot	NONE (default), 0
SP.DIGOUT#n	Digital output	1-4, 1 (default)
SP.SENSE#n	Digital output sense	NORMAL (default), INVERT
SP.BRANCH#n	Branch destination (0 = do not branch)	0-8, 0 (default)
SP.RELNUM#n	Relative setpoint number	1-8, 1 (default)
SP.START#n	Starting setpoint	1-8, 1 (default)
SP.END#n	Ending setpoint	1-8, 1 (default)
SP.TIME#n	Trip time	hhmm, 0000 (default)
SP.DURATION#n	Trip duration	hhmmss, 000000 (default)
SP.ENABLE#n	Setpoint enable	OFF, ON (default)

For setpoint commands ending with #n, n is the setpoint number (1-8)

Table 7-10. Setpoints Commands

7.11 Print Format Commands

Command	Description	Values
GFMT GFMT.PORT GFMT.PORT2	Gross demand print format string	Each format can be sent out one or two ports; for the .PORT and .PORT2 commands, specify the port name as one of the following: RS232-1, RS232-2, RS485, TCPC, TCPS, USB, NONE <i>Example: To send the Gross format out both RS-232 Port 2 and the USB Port at the same time, send:</i> GFMT.PORT=RS232-1 GFMT.PORT2=USB See Section 8.0 on page 54 for information about demand print format strings
NFMT NFMT.PORT NFMT.PORT2	Net demand print format string	
ACCFMT ACC.PORT ACC.PORT2	Accumulator print format string	
SPFMT SPFMT.PORT SPFMT.PORT2	Setpoint print format string	
HDRFMT1 HDRFMT2	Ticket header format strings	
AUD.PORT AUD.PORT2	Audit trail port	

Table 7-11. Print Format Commands

7.12 Digital I/O Commands

Command	Description	Values
DIO. <i>b</i> # <i>s</i>	Sets DIO type	OFF (default), OUTPUT, PRIM, PRINT, SEC, TARE, UNITS, ZERO, BATRUN, BAT-STRT, BATPAUS, BATRESET, BATSTOP, CLEAR, CLRACC, CLRCN, CLRTAR, DSPACC, DSPTAR, GROSS, KBDLOC, NET, NT/GRS

Valid bit values (*b*) are 1-4; For commands ending with #*s*, *s* is the slot assigned to the digital I/O (0); Slot 0 is onboard

Table 7-12. Digital I/O Commands

7.13 Analog Output Commands

Command	Description	Values
ALG.SOURCE# <i>s</i>	Analog output source	SCALE1 (default), REMOTE
ALG.MODE# <i>s</i>	Mode	GROSS (default), NET
ALG.OUTPUT# <i>s</i>	Type of output	0-10V (default), 0-20MA, 4-20MA
ALG.ERRACT# <i>s</i>	Error action	FULLSC (default), HOLD, ZEROSC
ALG.MIN# <i>s</i>	Minimum value tracked	±999999.0, 0.0 (default)
ALG.MAX# <i>s</i>	Maximum value tracked	±999999.0, 10000.0 (default)
ALG.TWZERO# <i>s</i>	Adjusts the offset of the analog output zero value	0-65535, 0 (default)
ALG.TWSPAN# <i>s</i>	Adjusts the offset of the analog output span value	0-65535, 59515 (default)

For commands ending with #*s*, *s* is the slot number assigned to the analog output (1)

Table 7-13. Analog Output Commands

7.14 Weigh Mode Commands

These commands function in the weigh mode. Non weight related commands work in setup mode.

Command	Description	Values
P	Returns what the indicator is currently displaying	--
ZZ	Returns what the indicator is currently display along with the currently displayed annunciators	See Section 11.2 on page 63
CONSNUM	Returns current consecutive number value	0–999999, 0 (default)
UID	Sets the unit ID	Up to 8 alphanumeric characters, 1 (default)
S	Returns a single stream frame from the displayed scale using the currently configured stream format	--
SD	Sets or returns the current system date	MMDDYY, DDMMYY, YYMMDD, or YYDDMM. Enter six-digit date using the year-month-day order specified for the DATFMT parameter, using only the last two digits of the year; The current system date is returned by only sending SD
ST	Sets or returns the current system time	HHMM (enter using 24-hour format) The current system time is returned by only sending ST
STS	Sets or returns the current system time with seconds	HHMMSS (enter using 24-hour format) The current system time is returned by only sending STS
RS	Resets system	Soft reset; Used to reset the indicator without resetting the configuration to the factory defaults
SX	Starts all serial data streams	--
EX	Stops all serial data streams	--
SX#p	Starts serial data stream for port p	OK or ??
EX#p	Stops serial data stream for port p	An EX command sent while in setup mode does not take effect until the indicator is returned to weigh mode
SF#n	Returns a single stream frame from scale n using the currently configured stream format.	--
XA#n	Returns the accumulator value in displayed units	nnnnnnnn UU
XAP#n	Returns the accumulator value in primary units	
XAS#n	Returns the accumulator value in secondary units	
XG#n	Returns the gross weight in displayed units	nnnnnnnn UU
XGP#n	Returns the gross weight in primary units	
XGS#n	Returns the gross weight in secondary units	
XN#n	Returns the net weight in displayed units	nnnnnnnn UU
XNP#n	Returns the net weight in primary units	
XNS#n	Returns the net weight in secondary units	
XT#n	Returns the tare weight in displayed units	nnnnnnnn UU
XTP#n	Returns the tare weight in primary units	
XTS#n	Returns the tare weight in secondary units	

For commands ending with #n, n is the scale number (1); For commands ending with #p, p is the port number (1-6), see [Section 7.5.1 on page 47](#)

Table 7-14. Weigh Mode Commands

7.14.1 CPU Port Numbering for SX/EX commands

- Ports 1 and 2 are the two RS-232 ports
- Port 3 is the RS-485/422 port
- Port 4 is the USB device port
- Port 5 is the TCP Server
- Port 6 is the TCP Client

7.15 Batching Control Commands

The commands listed in [Table 7-15](#) provide batching control through a communications port.

Command	Description	Values
BATSTART	Batch Start	If the BATRUN digital input is active or not assigned, the BATSTART command can be used to start the batch program
BATSTOP	Batch Stop	Stops an active batch and turns off all associated digital outputs; Requires a Batch Start to resume processing
BATPAUSE	Batch Pause	Pauses an active batch and turns off all digital outputs except those associated with Concurrent and Timer setpoints; processing is suspended until the indicator receives a Batch Start signal; pressing the BATSTR digital input, BATSTART serial command, Batch Start softkey resumes the batch and re-energizes all digital outputs turned off by the Batch Pause
BATRESET	Batch Reset	Stops the program and resets the batch program to the first batch step; use the BATRESET command after making changes to the batch configuration
BATSTATUS	Batch Status	Returns XYYY where X is S (if the batch is stopped), P (if the batch is paused), R (if the batch is running); and YYY is the setpoint number the batch is currently on (1-8)

Table 7-15. Batching Control Commands

8.0 Print Formatting

The 680HE provides multiple print formats, GFMT, NFMT, ACMFMT, SPTFMT and HDRFMT, which determine the format of the printed output when the **Print** key is pressed. If a tare has been entered or acquired, NFMT is used; otherwise, GFMT is used.

Each print format can be customized to include up to 1000 characters of information, such as company name and address, on printed tickets. Use the print format menu through front panel of the indicator to customize the print formats.



NOTE: Press the down arrow to view the ASCII character decimal value on the second menu level.

NOTE: See [Section 11.9 on page 71](#) to view the ASCII character chart.

8.1 Print Formatting Tokens

[Table 8-1](#) lists tokens which can be used to configure the print formats. Tokens included in the format strings must be enclosed between < and > delimiters. Characters outside of the delimiters are printed as text on the ticket. Text characters can include ASCII characters which can be printed by the output device.

Token	Description	Supported Ticket Formats
<i>General Weight Data Tokens</i>		
<Gx>	Gross weight, current scale	GFMT, NFMT, ACMFMT, STPFMT
<Gx#n>	Gross weight, scale <i>n</i>	
<Nx>	Net weight, current scale	
<Nx#n>	Net weight, scale <i>n</i>	
<Tx>	Tare weight, current scale	
<Tx#n>	Tare weight, scale <i>n</i>	
<S>	Current scale number	
<p>NOTE: For tokens with #<i>n</i>, <i>n</i> is the scale number (1). For tokens with an <i>x</i>, <i>x</i> is the character width of the weight field with padded spaces on the left. If <i>x</i> is not specified, 10 is the assumed default for the weight field. <i>x</i> can be set using one or two digits and sets the minimum number of characters in the weight field, but expands to show all characters for a value that has more characters than the minimum value set with <i>x</i>.</p> <p>Example: To format a ticket to provide gross weight for Scale 1 with a minimum of 6 print characters, use the following token: <G6#1></p> <p>NOTE: Gross, net and tare weights can be printed in any configured weight unit by adding modifiers to the gross, net, and tare weight tokens: /P (primary units), /D (displayed units), /S (secondary units). If not specified, the currently displayed unit (/D) is assumed.</p> <p>Example: To format a ticket to provide net weight in secondary units, use the following token: <N/S></p> <p>NOTE: Formatted weight strings default to contain a 10-digit weight field (including sign and decimal point), followed by a space and a 2-digit unit identifier. Total field length with unit identifier is 13 characters. For tokens with an <i>x</i>, total field length with unit identifier is <i>x</i> + 3.</p>		
<i>Accumulator Tokens</i>		
<A>	Accumulated weight, current scale; Prints to 15 digits	GFMT, NFMT, ACMFMT
<A#n>	Accumulated weight, scale <i>n</i>	
<AA>	Average accumulation, current scale	
<AA#n>	Average accumulation, scale <i>n</i>	
<AC>	Number of accumulations, current scale	
<AC#n>	Number of accumulations, scale <i>n</i>	
<AT>	Time of last accumulation, current scale	
<AT#n>	Time of last accumulation, scale <i>n</i>	
<AD>	Date of last accumulation, current scale	
<AD#n>	Date of last accumulation, scale <i>n</i>	
NOTE: For tokens with # <i>n</i> , <i>n</i> is the scale number (1).		

Table 8-1. Print Format Tokens

Token	Description	Supported Ticket Formats
Setpoint Tokens		
<SCV>	Setpoint captured value	STPFMT
<SN>	Setpoint number	
<SNA>	Setpoint name	
<SPM>	Setpoint mode (gross or net label)	
<SPV>	Setpoint preact value	
<STV>	Setpoint target value	
Auditing Tokens		
<CD>	Last calibration date	All
<NOC>	Number of calibrations	
<NOW>	Number of weighments since last calibration	
NOTE: Last calibration date (<CD>) and number of calibrations (<NOC>) are updated anytime a calibration is performed on any of the scales. Number of weighments (<NOW> token) is incremented whenever the scale weight exceeds 10% of scale capacity. Scale must return to gross or net zero before the value can be incremented again.		
Formatting and General-Purpose Tokens		
<nnn>	ASCII character (<i>nnn</i> = decimal value of ASCII character); used for inserting control characters (STX, for example) in the print stream	All
<TI>	Time	
<DA>	Date	
<TD>	Time and date	
<UID>	Unit ID number (up to 8 alphanumeric characters)	
<CN>	Consecutive number (up to 7 digits)	
<H1>	Insert header format 1 (HDRFMT1), see Table 8-2 on page 56	
<H2>	Insert header format 2 (HDRFMT2), see Table 8-2 on page 56	
<COMP>	Company name (up to 30 characters)	All
<COAR1> <COAR2> <COAR3>	Contact company address, lines 1–3 (up to 30 characters)	
<CONM1> <CONM2> <CONM3>	Contact names (up to 20 characters)	
<COPH1> <COPH2> <COPH3>	Contact phone numbers (up to 20 characters)	
<COML>	Contact e-mail address (up to 30 characters)	
<CR>	Carriage return character	
<LF>	Line feed character	
<NLnn>	New line (<i>nn</i> = number of termination (<CR/LF> or <CR>) characters)*	
<SPnn>	Space (<i>nn</i> = number of spaces)*	
<SU>	Toggle weight data format (formatted/unformatted)	
NOTE: If <i>nn</i> is not specified, 1 is assumed. Value must be in the range 1–99.		

Table 8-1. Print Format Tokens (Continued)

Table 8-2 lists the default 680HE print formats:

Format	Default Format String	When Used
GFMT	GROSS<G><NL2><TD><NL>	Weigh mode – no tare in system
NFMT	GROSS<G><NL>TARE<SP><T><NL>NET<SP2><N><NL2><TD><NL>	Weigh mode – tare in system
ACMFMT	ACCUM <A><NL><DA> <TI><NL>	Accumulator demand print format string
SPTFMT	<SCV><SP><SPM><NL>	Setpoint print operation with PSHPR=ON or WAITSS
HDFMT1-2	COMPANY NAME<NL>STREET ADDRESS<NL>CITY ST ZIP<NL2>	

Table 8-2. Default Print Formats



NOTE: The 1000 character limit of each print format string includes the output field length of the print formatting tokens, not the token length. For example, if the indicator is configured to display a decimal point, the <G> token generates an output field of 13 characters: the 10 character weight value (including decimal point), one space, and a two-digit units identifier. For tokens with an x (e.g. <Gx> or <Gx#n>), total field length with unit identifier is x + 3.

NOTE: PT (preset tare) is added to the tare weight if tare was keyed in.

8.2 Customizing Print Formats

The GFMT, NFMT, ACMFMT, SPTFMT and HDRFMT formats can be customized using the print format menu (PF₀₋₁₁) via the front panel. See Section 4.4.6 on page 33 for the print format menu structure. To access the print format menu the indicator must be in setup mode (Section 4.1 on page 21).

8.2.1 Using the Front Panel

Use the print format menu to customize the print formats and to edit the print format strings by changing the ASCII characters in the format string. See Section 3.3.2 on page 16 for the alphanumeric entry procedure to edit the print format string.



NOTE: Some characters cannot be displayed on the 680HE front panel, see the ASCII character chart in Section 11.9 on page 71 for available characters. The 680HE can send or receive ASCII characters; the character printed depends on the particular ASCII character set implemented for the receiving device.

8.3 Non-Human Readable Characters

ASCII characters 0 through 31 are non-human readable characters. Since these characters are not visible, they do not appear as selectable options in a 680HE print format. To include a special character in a print format, the decimal equivalent needs to be used. For example, the special character *Esc* would be <27> or 60, 50, 55, 62 (less the commas).

Examples of a print release command for a TMU295 in the GROSS format:

Print Format:

GROSS<G><NL2><TD><NL><27>q

In Revolution:

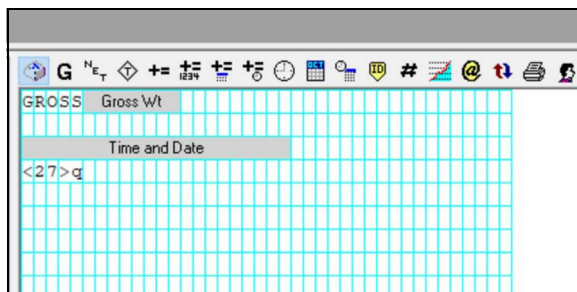

Print Format:

GROSS<G><NL2><TD><NL><27><113>

In Revolution:

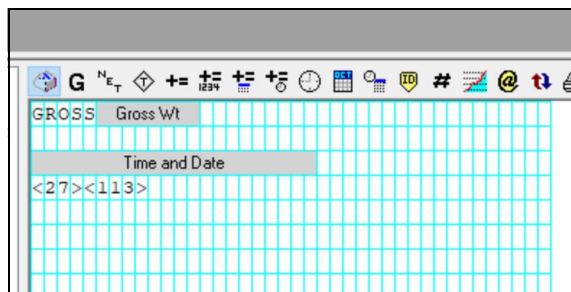

9.0 Setpoints

The 680HE indicator provides eight configurable setpoints for control of both indicator and external equipment functions. Setpoints can be configured to perform actions or functions based on specified parameter conditions. Parameters associated with various setpoint kinds can, for example, be configured to perform functions (print, tare, accumulate), to change the state of a digital output controlling indicator or external equipment functions, or to make conditional decisions.



NOTE: *Weight-based setpoints are tripped by values specified in primary units only.*

9.1 Batch and Continuous Setpoints

680HE setpoints can be either continuous or batch.

Continuous setpoints are free-running; the indicator constantly monitors the condition of free-running setpoints at each A/D update. The specified setpoint action or function is performed when the designated setpoint parameter conditions are met. A digital output or function assigned to a free-running setpoint continuously changes state, becoming active or inactive, as defined by the setpoint parameters.

Batch setpoints (BATCH = ON) which have digital outputs associated to them remain active until the setpoint condition is met. The setpoint is then latched for the remainder of the batch sequence.

To use batch setpoints, set the batching (BATCHG) parameter on the setpoints (SETPTS) menu. This parameter defines whether a batch sequence is automatic or manual. AUTO sequences repeat continuously after receiving a single batch start signal, while MANUAL sequences only run through once for each Batch Start signal. The batch start signal can be initiated by a digital input (set to BATSTR), or an EDP command (BATSTART).

For a setpoint to be used as part of a batch sequence, its batch sequence (BATCH) parameter must be set to ON. If a setpoint is defined and enabled, but its Batch Sequence parameter is set to OFF, the setpoint operates as a continuous setpoint even during batch sequences.



NOTE: *In applications which contain both batch setpoint routines and continuous setpoints, it is good practice to keep continuous setpoints separate from the batch sequence.*

NOTE: *Do not assign them the same digital output.*

NOTE: *Set the ACCESS parameter ON when creating and testing batch routines. Once the batching routine is complete and ready for production, ACCESS can be set to OFF to prevent changes to the configured setpoint value, or to HIDE to prevent changing or viewing the value.*

Parameter	Description	Batch	Continuous
OFF	Off – Setpoint turned off/ignored		
GROSS	Gross Weight – Performs functions based on the gross weight; the target weight entered is considered a positive gross weight	X	X
NET	Net Weight – Performs functions based on the net weight; the target weight entered is considered a positive net weight value	X	X
-GROSS	Negative Gross Weight – Performs functions based on the gross weight; the target weight entered is considered a negative gross weight	X	X
-NET	Negative Net Weight – Performs functions based on the net weight; the target weight entered is considered a negative net weight value	X	X
ACCUM	Accumulate – Compares the value of the setpoint to the source scale accumulator; the accumulator setpoint is satisfied when the value of the source scale accumulator meets the value and conditions of the accumulator setpoint	X	X
POSREL	Positive Relative – Performs functions based on a specified value above a referenced setpoint, using the same weight mode as the referenced setpoint	X	X
NEGREL	Negative Relative – Performs functions based on a specified value below a referenced setpoint, using the same weight mode as the referenced setpoint	X	X

Table 9-1. Setpoint Kinds

Parameter	Description	Batch	Continuous
PCTREL	Percent Relative – Performs functions based on a specified percentage of the target value of a referenced setpoint, using the same weight mode as the referenced setpoint; the actual target value of the Percent Relative setpoint is calculated as a percentage of the target value of the referenced setpoint	X	X
PAUSE	Pause – Pauses the batch sequence indefinitely; a Batch Start signal must be initiated to continue the batch process	X	
DELAY	Delay – Delays the batch sequence for a specified time; the length of the delay (in tenths of a second) is specified on the Value parameter	X	
WAITSS	Wait Standstill – Suspends the batch sequence until the scale is at standstill	X	
COUNTR	Counter – Specifies the number of consecutive batch sequences to perform; place counter setpoints at the beginning of a batch routine	X	
AUTOJG	Auto-Jog – Automatically checks the previous weight-based setpoint to verify the setpoint weight value is satisfied in a standstill condition <ul style="list-style-type: none"> If the previous setpoint is not satisfied when at standstill, the AUTOJG setpoint activates the digital output of the previous weight-based setpoint for a period of time, specified on the Value parameter (in tenths of a second) The AUTOJG process repeats until the previous weight-based setpoint is satisfied when the scale is at standstill <p>NOTE: The AUTOJG digital output is typically used to signify an AUTOJG operation is being performed.</p> <p>NOTE: AUTOJG uses the digital output of the previous weight-based setpoint, and should not be assigned to the same digital output as the related weight-based setpoint.</p>	X	
COZ	Center of Zero – Monitors for a gross center of zero condition <ul style="list-style-type: none"> The digital output associated with this setpoint kind is activated when the referenced scale is at center of zero No value is required for this setpoint 		X
INMOTN	In-Motion – Monitors for an in-motion condition <ul style="list-style-type: none"> The digital output associated with this setpoint is activated when scale is not at standstill No value is required for this setpoint 		X
INRNGE	In-Range – Monitors for an in-range condition <ul style="list-style-type: none"> The digital output associated with this setpoint is activated when the scale is within capacity range No value is required for this setpoint 		X
TIMER	Timer – Tracks the progress of a batch sequence based on a timer <ul style="list-style-type: none"> The timer value, in tenths of a second, determines the length of time allowed between start and end setpoints Start and End parameters are used to specify the start and end setpoints If the End setpoint is not reached before the timer expires, the digital output associated with this setpoint is activated 		X
CONCUR	Concurrent – Allows a digital output to remain active over a specified portion of the batch sequence <ul style="list-style-type: none"> Type 1 (VALUE=0): The digital output associated with this setpoint becomes active when the Start setpoint becomes the current batch step and remains active until the End setpoint becomes the current batch step Type 2 (VALUE > 0): If a non-zero value is specified for the Value parameter, the value represents the timer, in tenths of a second, for this setpoint; The digital output associated with this setpoint becomes active when the Start setpoint becomes the current batch step and remains active until the timer expires 		X
TOD	Time of Day – Performs functions when the internal clock time of the indicator matches the specified setpoint time	X	X
ALWAYS	Always – This setpoint is always satisfied; It is typically used to provide an endpoint for true/false branching batch routines	X	
NEVER	Never – This setpoint is never satisfied <ul style="list-style-type: none"> Used to branch to a designated setpoint in true/false branching batch routines in which the batch does not continue through the normal sequence of batch setpoints 	X	

Table 9-1. Setpoint Kinds (Continued)

9.2 Batching Examples

9.2.1 Example 1

The following example uses seven setpoints to dispense material from a hopper in 100 lb batches and to automatically refill the hopper when its weight drops below 300 lb.

Bits 1 and 2 in the Digital I/O menu ([Section 4.4.9 on page 38](#)) are assigned to batch start and batch run functions: BATRUN must be on (low) before the BATSTRT input starts the batch.

```
SLOT 0, BIT 1=BATSTRT
SLOT 0, BIT 2=BATRUN
BATCHNG=MANUAL
```

Setpoint 1 ensures the hopper has enough material to start the batch. If the hopper weight is 300 lb or higher, setpoint 1 is tripped.

```
SETPT 1          TRIP=HIGHER
KIND=GROSS      ALARM=ON
VALUE=300      BATCH=ON
```

Setpoint 2 waits for standstill, then performs a tare to put the indicator into net mode.

```
SETPT 2
KIND=WAITSS
PSHTARE=ON
```

Setpoint 3 is used as a reference (relative setpoint) for setpoint 4.

```
SETPT 3          TRIP=HIGHER
KIND=NET         BATCH=OFF
VALUE=0
```

Setpoint 4 is used to dispense material from the hopper. When the hopper weight falls to 100 lb less than its weight at the relative setpoint (setpoint 3), digital output 1 is set off.

```
SETPT 4          DIG OUT=1
KIND=NEGREL     BATCH=ON
VALUE=100      RELNUM=3
TRIP=LOWER
```

Setpoint 5 is used to evaluate the gross amount of material in the hopper after dispensing, and to maintain a minimum material level in the hopper. When the hopper weight falls below 300 lb, digital output 2 becomes active and the hopper is refilled to 1000 lb.

```
SETPT 5          HYSTERS=700
KIND=GROSS      DIG OUT=2
VALUE=300      BATCH=ON
TRIP=HIGHER
```

Setpoint 6 is used to ensure the operation performed in setpoint 4 is completed within 10 seconds. The START and END parameters identify the setpoints monitored by the timer. If the timer expires before setpoint 5 starts, digital output 4 is turned on as an alarm to signal a process fault.

```
SETPT 6          START=4
KIND=TIMER      END=5
VALUE=100      DIG OUT=4
```

9.2.2 Example 2

The following example uses six setpoints to control a two-speed fill operation where both fast and slow feeds are on simultaneously.

Bits 1 and 2 in the Digital I/O menu ([Section 4.4.9 on page 38](#)) are assigned to batch start and batch run functions: BATRUN must be on (low) before the BATSTRT input starts the batch.

```
SLOT 0, BIT 1=BATSTRT
SLOT 0, BIT 2=BATRUN
BATCHNG=MANUAL
```

Setpoint 1 ensures the scale is empty (0 ± 2 lb).

```
SETPT 1          TRIP=INBAND
KIND=GROSS      BANDVAL=2
VALUE=0         BATCH=ON
```

Setpoint 2 checks for the weight of a container (>5 lb) placed on the scale.

```
SETPT 2          TRIP=HIGHER
KIND=GROSS      BATCH=ON
VALUE=5
```

Setpoint 3 waits for standstill, then tares the container weight, placing the indicator in net mode.

```
SETPT 3
KIND=WAITSS
PSHTARE=ON
```

Setpoint 4 starts the fast fill operation. When the net weight reaches 175 lb, the setpoint trips and digital output 1 is set off.

```
SETPT 4          TRIP=HIGHER
KIND=NET         DIG OUT=1
VALUE=175       BATCH=ON
```

Setpoint 5 controls the slow fill operation. When the net weight reaches 200 lb, the slow fill is stopped, the indicator waits for standstill and performs a push print operation using the SPFMT ticket format.

```
SETPT 5          PSHPRNT=WAITSS
KIND=NET         DIG OUT=2
VALUE=200       BATCH=ON
TRIP=HIGHER
```

Setpoint 6 is a continuous setpoint, used to allow the slow feed output to be on at the same time as the fast fill. The slow fill output (digital output 2) is turned on when setpoint 4 (fast fill) starts and remains on until setpoint 5 begins.

```
SETPT 6          START=4
KIND=CONCUR     END=5
VALUE=0         DIG OUT=2
```

10.0 Maintenance

The maintenance information in this manual is designed to cover aspects of maintaining and troubleshooting the 680HE indicator. Contact the local Rice Lake Weighing Systems dealer if a problem requires technical assistance.



NOTE: Have the scale model number and serial number available when calling for assistance.

10.1 Maintenance Checkpoints

The scale must be checked frequently to determine when a calibration is required. It is recommended a zero calibration be checked every other day and a calibration checked every week for several months after installation. Observe the results and change the period between calibration checks, depending upon the accuracy desired.



NOTE: Establish a routine inspection procedure. Report changes in the scale function to the individual or department responsible for the scales' performance.

10.2 Field Wiring

If a problem with the wiring is suspected, check the electrical portion of the scale.

- Check for proper interconnections between the components of the system
- Check wiring meets all specifications in the installation drawings
- Check all wiring and connections for continuity, shorts and grounds using an ohmmeter with the scale off
- Check for loose connections, poor solder joints, shorted or broken wires and unspecified grounds in wiring; these issues cause erratic readings and shifts in weight readings
- Check all cable shields to ensure grounding is made at only the locations specified in the installation drawings

10.3 Troubleshooting Tips

Table 10-1 lists general troubleshooting tips for hardware and software error conditions

Symptom	Possible Cause	Remedy
680HE does not power up	Bad power supply	Check power supply; Check presence of AC power – breaker tripped or unit unplugged; Power supply outputs around 12 VDC – replace if bad
Battery backed corrupt error message at startup	Dead battery	Perform configuration reset then check for low battery warning on display; If battery is low, replace battery, perform another configuration reset, then reload files/configuration
nnnnnn or uuuuuu	Over or under range scale condition	Check scale; For out-of-range conditions in total scale display, check all scale inputs for positive weight values
Cannot enter setup mode	Bad jumper	Test jumper
Serial port not responding	Wiring or Configuration error	Verify wiring and ensure port INPUT parameter is set to CMD for command input
A/D scale out of range	Scale operation Load cell connection Bad load cell	Check source scale for proper mechanical operation Check load cell and cable connection Check 680HE operation with load cell simulator Check status of sense settings
Option card failure	Possible defective card or slot	Disconnect power, remove and reinstall card in slot, then apply power again

Table 10-1. Basic Troubleshooting

10.4 Battery Replacement

The battery life varies depending on use. It is recommended to replace the battery every three years, or sooner, if left powered off for extended periods of time, to prevent data loss in the event of a power failure.

Use Revolution ([Section 6.0 on page 43](#)) or EDP commands ([Section 7.0 on page 44](#)) to store a copy of the 680HE configuration on a PC before attempting battery replacement. 680HE configuration can be restored from the PC if data is lost.



WARNING: Risk of explosion if battery is replaced with an incorrect type. Dispose of used batteries according to federal, state and local regulations.



IMPORTANT: Use anti-static protection for grounding and to protect components from electrostatic discharge (ESD) when working inside the 680HE enclosure. Procedures requiring work inside the 680HE must be performed by qualified service personnel only.

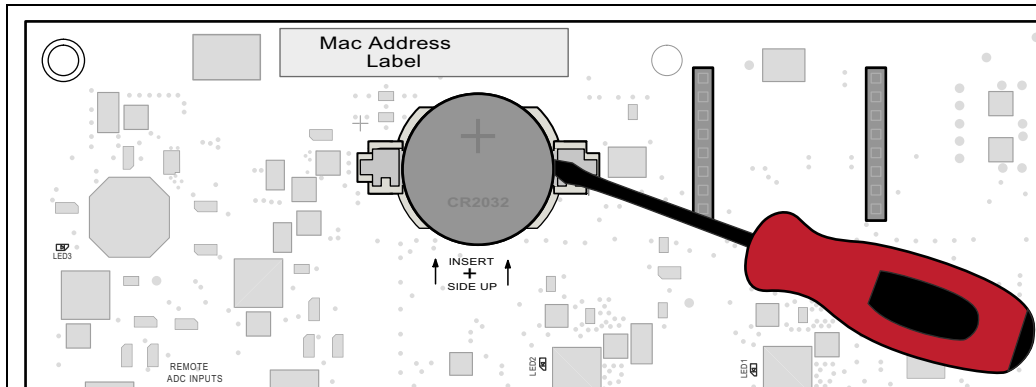

Figure 10-1. Non-Conductive Screw Driver Placement

To replace the battery, use the following procedure:

1. Disconnect power to the indicator.
2. Release the two latches and carefully swing open the front door of the enclosure.
3. Place the tip of a non-conductive flat head screw driver between negative contact and battery.
4. Twist screw driver to release battery from holder.
5. Press new replacement battery straight into the battery holder with the positive side up. See [Section 2.8 on page 13](#) for replacement battery details.

10.5 Board Replacement



IMPORTANT: Use anti-static protection for grounding and to protect components from electrostatic discharge (ESD) when working inside the 680HE enclosure. Procedures requiring work inside the 680HE must be performed by qualified service personnel only.

To replace a 680HE board, use the following procedure:

1. Disconnect power to the indicator.
2. Release the two latches and carefully swing open the front door of the enclosure.
3. Label connections for re-installation to board.
4. Disconnect all connections from the board.
5. Remove the four corner screws securing the board.
6. Slightly lift up on the board and disconnect the overlay ribbon from the J26 connector on the reverse side of the board.
7. Attach the overlay ribbon to the new board by pressing the end up against the J26 connector while it is still closed. Open the J26 connector and then close it once the end of the overlay ribbon has seated itself inside the connector.
8. Place the new replacement board into the enclosure and secure with the four previously removed screws.
9. Reconnect all connections to the board. See [Section 2.5 on page 11](#) for details on the board connectors.



IMPORTANT: Always verify indicator has been returned back to a safe state with the proper installation of all connections and a complete functions test before returning the indicator back to service.

11.0 Appendix

11.1 Error Messages

The 680HE indicator provides a number of error messages. When an error occurs, the message is displays on the indicator.

11.1.1 Displayed Error Messages

The 680HE provides a number of front panel error messages to assist in problem diagnosis. [Table 11-1](#) lists these messages and their meanings.

Error Message	Description
-----	Overflow error – Weight value too large to be displayed
nnnnnn	Gross > overload limit – Gross value exceeds overload limit; Check configuration or signal input level; Overload can be caused by input signal > 45 mV or common mode voltage > 950 mV
uuuuuu	Gross < underload limit – Gross value exceeds underload limit
bAtteErY LoW	Scrolls across display every 30 seconds when battery is low
tArE in mOtiOn nOt AllOwEd	Scrolls across display when attempting to perform a tare while weight is in motion, if in motion tares are not allowed
nEGAtiVe tArE nOt AllOwEd	Scrolls across display when attempting to perform a negative tare, if a negative tare is not allowed
KeyEd tArE nOt AllOwEd	Scrolls across display when attempting to perform a keyed tare, if a keyed tare is not allowed
tArE lArGEr tHAn cAPAcitY nOt AllOwEd	Scrolls across display when attempting to perform a tare larger than capacity, if it is not allowed
tArE ALrEdY in SYStEm	Scrolls across display when attempting to perform a tare if a tare is already in the system, if tare is not configured to replace or remove
iniTiAl zErO FRiLEd	Scrolls across display when an attempt to perform an initial zero fails, only possible at startup
PLERSE zR.t	Scrolls across display when calibrating
ALARn	Displays when a configured setpoint's ALARM action occurs

Table 11-1. 680HE Error Messages

11.2 ZZ EDP Command

The ZZ EDP command can be used to remotely query the value currently displayed on the 6-digit display, along with the units, and a number representing the current state of the 8 LED annunciators. The number represents the LED annunciators currently lit ([Table 11-2](#)).

Example: If the ZZ command returns “2500 LB 145”, that means the weight on the display is 2500 pounds, and the gross, standstill, and lb annunciators are lit. The number 145 represents the sum of the values for the gross mode annunciator (16), the standstill annunciator (128), and the lb annunciator (1).

Decimal Value	Annunciator
1	lb/primary units
2	kg/secondary units
4	Tare entered
8	Keyed tare entered
16	Gross
32	Net
64	Center of zero
128	Standstill

Table 11-2. Status Codes Returned on the ZZ Command

11.3 Continuous Data (Stream) Output Formats

When the trigger setting for a port is set to STRIND or STRLFT, data is continuously streamed from the appropriate port in one of the four fixed format options or a custom format option.

Fixed Format Options:

- Rice Lake Weighing Systems (Section)
- Cardinal (Section)
- Avery Weigh-Tronix (Section on page 65)
- Mettler Toledo (Section on page 65)

Rice Lake Weighing Systems Stream Format (rL5)

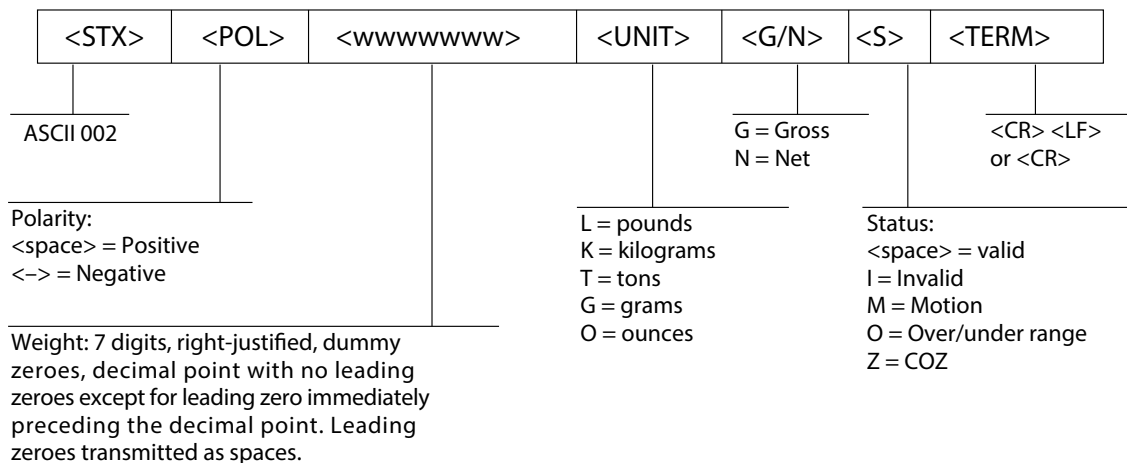

Figure 11-1. Rice Lake Weighing Systems Stream Data Format

Cardinal Stream Format (rLnRl)

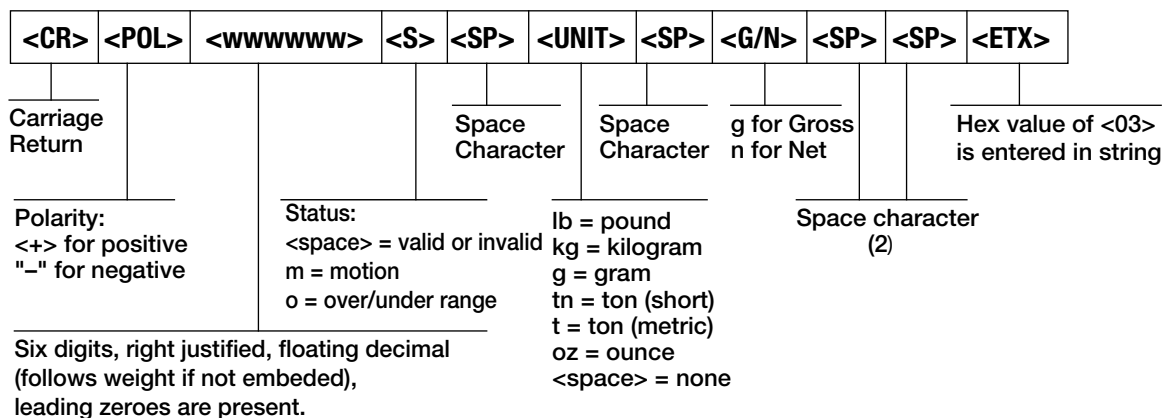

Figure 11-2. Cardinal Stream Data Format

Avery Weigh-Tronix Stream Format (αβγδ εζ)

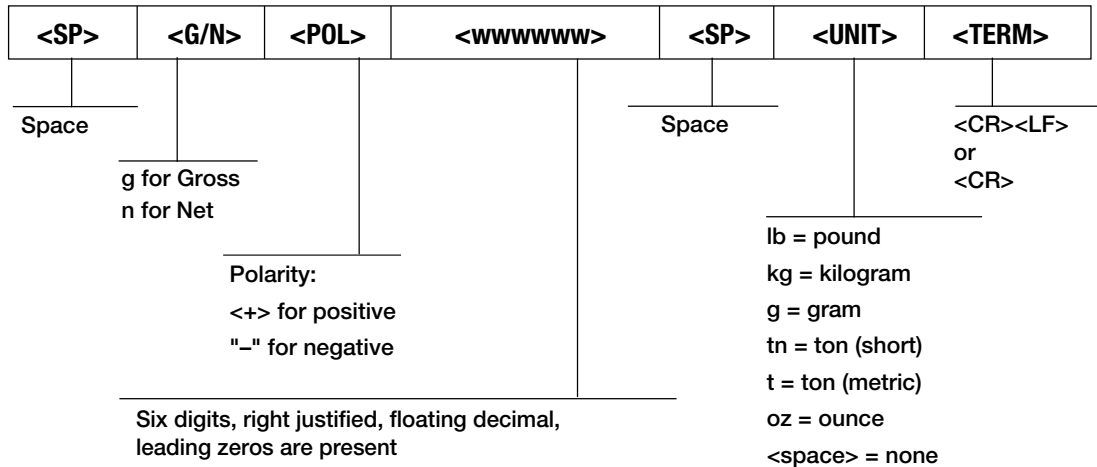

Figure 11-3. Avery Weigh-Tronix Stream Data Format

Mettler Toledo Stream Format (εζηθ ικλμ)

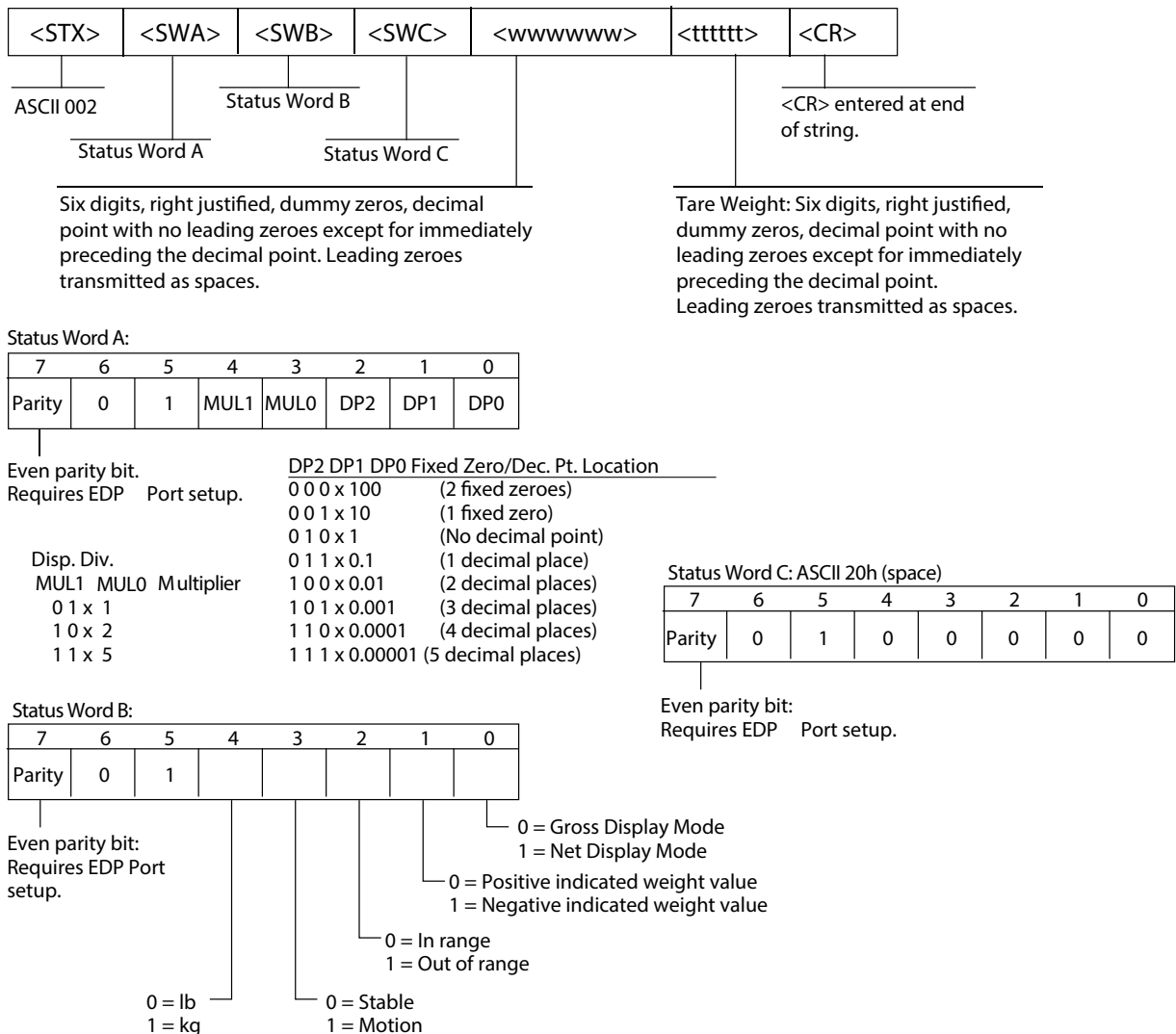

Figure 11-4. Mettler Toledo Stream Data Format

11.4 Custom Stream Formatting

The Custom stream format parameter can be configured in the Stream Format menu via the front panel. See [Section 4.4.7 on page 34](#) for the Stream Format menu structure. The indicator must be in setup mode ([Section 4.1 on page 21](#)) to access the Stream Format menu.

Using the Front Panel

Use the Stream Format menu to customize the Custom parameter by changing the ASCII characters in the format string.

Setup ▼ to Configure ► to SFormt ▼ to SFmt (set to Custom) ► to Custom ▼ to format string entry

See [Section 3.3.2 on page 16](#) for the alphanumeric entry procedure to edit the format string.



NOTE: The 680HE can send or receive ASCII characters; the character printed depends on the particular ASCII character set implemented for the receiving device. Some characters cannot be displayed on the 680HE front panel, see the ASCII character chart in [Section 11.9 on page 71](#) for available characters and see [Section 8.3 on page 56](#) for a description of Non-Human Readable Characters.

For example, enter the following string of format tokens to recreate the standard RLWS stream format as a custom stream format: <2><P><W7.><U><M><S><CR><LF>

- <2> Sends ASCII character 2, or STX.
- <P> Sends the Polarity character.
- <W7.> Sends 7 weight digits, no leading zeros, with a floating decimal point as needed.
- <U> Sends the Units.
- <M> Sends the Mode.
- <S> Sends the Status.
- <CR> Sends a Carriage Return.
- <LF> Sends a Line Feed.

Custom Stream Format Tokens

Format Identifier	Defined By	Description
<P[G N T]>	STRM.POS# <i>n</i> STRM.NEG# <i>n</i>	Polarity – Specifies positive or negative polarity for the current or specified (Gross/Net/Tare) weight on the source scale; Possible values are SPACE, NONE, + (for STR.POS# <i>n</i>) or – (for STR.NEG# <i>n</i>)
<U[P S T]>	STRM.PRI# <i>n</i> STRM.SEC# <i>n</i> STRM.TER# <i>n</i>	Units – Specifies primary, secondary or tertiary units for the current or specified weight on the source scale
<M[G N T]>	STRM.GROSS# <i>n</i> STRM.NET# <i>n</i> STRM.TARE# <i>n</i>	Mode – Specifies gross, net or tare weight for the current or specified weight on the source scale
<S>	STRM.MOTION# <i>n</i> STRM.RANGE# <i>n</i> STRM.OK# <i>n</i> STRM.INVALID# <i>n</i> STRM.ZERO# <i>n</i>	Status for the source scale – Default values and meanings for each status: <ul style="list-style-type: none"> • STR.MOTION#<i>n</i> M In motion • STR.RANGE#<i>n</i> O Out of range • STR.OK#<i>n</i> <space> OK • STR.INVALID#<i>n</i> I Invalid • STR.ZERO#<i>n</i> Z COZ
<UID>	UID	Unit ID number – Specifies the unit identification number as an alphanumeric value up to 6 characters long
<###>	--	To send an ASCII character; ### is a number 0 to 255; for example: <2> sends the ASCII character 2, Start of Text (STX) and the token <13> sends a Carriage Return
XXXX	--	To send literal characters; XXXX represents literal characters to include in the string by not including <>; for example: SCALE<W7.><U><CR><LF> will stream "SCALE 1234 L" with a weight of 1234 pounds
<B [-]n,...>	See descriptions below	Bit fields. Comma-separated sequence of bit field specifiers; Must be exactly 8-bits; minus sign ([-]) inverts the bit
B0	--	Always 0

Table 11-3. Custom Stream Format Tokens

Format Identifier	Defined By	Description
B1	--	Always 1
B2	Configuration	=1 if even parity
B3	Dynamic	=1 if MODE=NET
B4	Dynamic	=1 if COZ
B5	Dynamic	=1 if standstill
B6	Dynamic	=1 if gross negative
B7	Dynamic	=1 if out of range
B8	Dynamic	=1 if secondary/tertiary
B9	Dynamic	=1 if tare in system
B10	Dynamic	=1 if tare is keyed
B11	Dynamic	=00 if MODE=GROSS =01 if MODE=NET =10 if MODE=TARE =11 (not used)
B12	Dynamic	=00 if UNITS=PRIMARY =01 if UNITS=SECONDARY =10 if UNITS=TERTIARY =11 (not used)
B13	Configuration	=00 (not used) =01 if current DSPDIV=1 =10 if current DSPDIV=2 =11 if current DSPDIV=5
B14	Configuration	=00 (not used) =01 if primary DSPDIV=1 =10 if primary DSPDIV=2 =11 if primary DSPDIV=5
B15	Configuration	=00 (not used) =01 if secondary DSPDIV=1 =10 if secondary DSPDIV=2 =11 if secondary DSPDIV=5
B17	Configuration	=000 if current DECPNT=8888800 =100 if current DECPNT=88888.88 =001 if current DECPNT=8888880 =101 if current DECPNT=8888.888 =010 if current DECPNT=8888888 =110 if current DECPNT=888.8888 =011 if current DECPNT=888888.8 =111 if current DECPNT=88.88888
B18	Configuration	=000 if primary DECPNT=8888800 =100 if primary DECPNT=88888.88 =001 if primary DECPNT=8888880 =101 if primary DECPNT=8888.888 =010 if primary DECPNT=8888888 =110 if primary DECPNT=888.8888 =011 if primary DECPNT=888888.8 =111 if primary DECPNT=88.88888
B19	Configuration	=000 if secondary DECPNT=8888800 =100 if secondary DECPNT=88888.88 =001 if secondary DECPNT=8888880 =101 if secondary DECPNT=8888.888 =010 if secondary DECPNT=8888888 =110 if secondary DECPNT=888.8888 =011 if secondary DECPNT=888888.8 =111 if secondary DECPNT=88.88888
<wspec [-] [0] digit [.[.][digit]]>	Scale weight	Weight for the source scale. wspec is defined as follows: wspec indicates whether the weight is the current displayed weight (W, w), gross (G, g), net (N, n) or tare (T, t) weight; Upper-case letters specify right-justified weights, lower-case are left-justified Optional /P, /S or /T suffixes can be added before the ending delimiter (>) to specify weight display in primary (/P), secondary (/S) or tertiary (/T) units [-] Enter a minus sign (-) to include sign for negative values [0] Enter a zero (0) to display leading zeros digit[.][digit] The first digit indicates the field width in characters; The decimal point only indicates a floating decimal; A decimal point with a following digit indicates fixed decimal with n digits to the right of the decimal; Two consecutive decimals send the decimal point even if it falls at the end of the transmitted weight field
<CR>	--	Carriage return
<LF>	--	Line feed

Table 11-3. Custom Stream Format Tokens (Continued)

11.5 Audit Trail Support

Audit trail support provides tracking information for configuration and calibration events. To prevent potential misuse, all configuration and calibration changes are counted as change events.

Audit trail information can be printed from Revolution or by sending the DUMPAUDIT serial reporting command. Revolution can be used to display audit trail information. The audit trail display includes the legally relevant (LR) version number (firmware version for the code which provides audit trail information), a calibration count and a configuration count.



NOTE: *The calibration and configuration counters are only incremented when Audit Trail is enabled.*

See [Section 3.4.10 on page 18](#) for steps to view the Audit Trail counters.

11.6 Conversion Factors for Secondary Units

The 680HE has the capability to mathematically convert a weight into many different types of units and instantly display those results with a press of the **Units** key.

Secondary units can be specified on the Format menu using the **SECNDR** parameter.



NOTE: *Multipliers are preconfigured within the indicator.*

NOTE: *Ensure the secondary decimal point position is set appropriately for the scale capacity in the secondary units.*

11.7 Digital Filtering

Digital filtering is used to create a stable scale reading in challenging environments. The 680HE allows selection of **Digital Rolling Average Filtering** ([Section 11.7.1](#)), **Adaptive Filtering** ([Section 11.7.2 on page 69](#)), **Damping** ([Section 11.7.3 on page 70](#)) or **None** (RAW) for no filtering. See [Section 4.4.1 on page 23](#) for configuration menu layout and the location of FLTCHN parameter.

The scale's sample rate effects all types of filtering. The A/D sample rate is selected by the SMPRAT scale parameter. The A/D sample rate is the number of weight readings the indicator takes per second (SMPRAT). This can be 6.25, 7.5, 12.5, 15, 25, 30, 50, 60 or 120 hertz (readings per second). Set the A/D sample rate to the lowest setting required for the application. Lower settings result in better stability.

11.7.1 Digital Rolling Average Filter (AVGONL)

The digital rolling average filter uses mathematical averaging with three stages. These configurable stages control the effect of a single A/D reading on the displayed weight. When an A/D reading outside of a predetermined band is encountered, the digital rolling average filter is overridden and the display jumps directly to the new value.

Digital Filter Stages (DIGFL1-3)

The filter stages can each be set to a value of 1–256. The value assigned to each stage sets the number of readings received from the preceding filter stage before averaging. Setting the filter stages to 1 effectively disables the rolling filter.

A rolling average is passed to successive filtering stages for an overall filtering effect which is effectively a weighted average of the product of the values assigned to the filter stages ($DIGFL1 \times DIGFL2 \times DIGFL3$) within a time frame corresponding to the sum of the values ($DIGFL1 + DIGFL2 + DIGFL3$).

Digital Filter Sensitivity (DFSENS) and Threshold (DFTHR)

The rolling averaging filter can be used by itself to eliminate vibration effects, but heavy filtering also increases settling time. The **DFSENS** and **DFTHR** parameters can be used to temporarily override filter averaging and improve settling time.

- **DFSENS** specifies the number of consecutive A/D readings which must fall outside the filter threshold (**DFTHR**) before filtering is suspended
- **DFTHR** sets a threshold value, in display divisions; When the specified number of consecutive A/D readings (**DFSENS**) fall outside of this threshold, filtering is suspended; Set **DFTHR** to **NONE** to turn off the filter override

Digital Rolling Average Filter Procedure

1. In setup mode, set the rolling filter stage parameters (*DIGFL1-3*) to 1.
2. Set *DFTHRH* to *NONE*.
3. Return to weigh mode.
4. Remove all weight from scale, then watch the indicator to determine the magnitude of vibration effects on the scale.
5. Record weight below which all but a few readings fall. This value is used to calculate the *DFTHRH* parameter in [step 8](#).
Example – if a heavy-capacity scale (10000 x 5 lb) produces vibration-related readings of up to 50 lb, with occasional spikes up to 75 lb, record 50 as the threshold weight value.
6. Place the indicator in setup mode and set the filter stage parameters (*DIGFL1-3*) to eliminate the vibration effects on the scale (leave *DFTHRH* set to *NONE*).
7. Find the lowest effect value for the *DIGFL1-3* parameters.

If needed, the digital filter cutout sensitivity (*DFSENS*) and the digital filter cutout threshold (*DFTHRH*) can be used to reset the digital rolling average filter so the response to a rate change is faster.

8. Calculate the *DFTHRH* parameter value by converting the weight value recorded in [step 5](#) to display divisions (*Threshold_Weight_Value / Display_Divisions*).
*In the example in [step 5](#), with a threshold value of 50, and a display divisions value of 5, set the *DFTHRH* parameter to 10 display divisions.*
9. Set the *DFSENS* parameter high enough to ignore transient peaks. Longer transients (typically caused by lower vibration frequencies) causes more consecutive out-of-band readings; set the *DFSENS* parameter higher to counter low frequency transients.

11.7.2 Adaptive Filter (ADPONL)

The adaptive filter has two settings, sensitivity (*ADSENS*) and threshold (*ADTHRH*). It maintains a running average of the A/D readings when the weight change remains less than the defined threshold value. The filter automatically applies less value to each successive A/D reading the longer the weight change is less than the threshold value. The amount of value given to the most recent A/D reading is determined by the sensitivity setting.

Adaptive Filter Sensitivity (ADSENS)

Adaptive filter sensitivity (*ADSENS*) can be set to *HEAVY*, *MEDIUM* or *LIGHT*. A *HEAVY* setting results in an output which is more stable to weight changes than the *LIGHT* setting. A *HEAVY* setting also results in small changes in weight data (a few grads) on the scale base to not be seen as quickly as with the *LIGHT* setting.

If the difference in typical subsequent weight values on the scale are only a few display divisions, use a *LIGHT* setting. On a truck scale where the changes in subsequent weight values are 100s of display divisions, a *HEAVY* setting is more appropriate.

Adaptive Filter Threshold (ADTHRH)

Set the adaptive filtering threshold (*ADTHRH*) for the amount of observed instability in the system. This parameter can be set in the range of 0–2000 and is entered as a weight value. When a new sampled weight value is acquired, the adaptive filter compares the new value to the previous (filtered) output value.

If the difference between the new value and the previous output value is greater than the *ADTHRH* parameter the adaptive filter is reset to the new weight value.

If the difference between the new value and the previous output value is less than the *ADTHRH* parameter, the two values are averaged together using a weighted average. The weighted average is based on the amount of time the system has been stable, and selected *ADSENS* sensitivity.

With the adaptive filter threshold set at zero, determine the amount of instability present. Enter this amount of weight instability to set the threshold of the adaptive filter. The adaptive filter is set to *OFF* the *ADTHRH* parameter is set to zero.

11.7.3 Damping Filter (DMPONL)

The damping filter is a simple filter which adjusts the amount of time it takes for a change in weight to be processed through the scale. The *DMPVL* parameter is a time interval specified in tenths of a second (10 = 1 second). This damping value is used to determine the amount of time it takes for the scale to reach its final weight output. When *DMPVL* is set to ten, a transition from 0 lb to 500 lb on the scale takes one second. The closer the weight gets to its final amount, the slower the weight changes on the display.

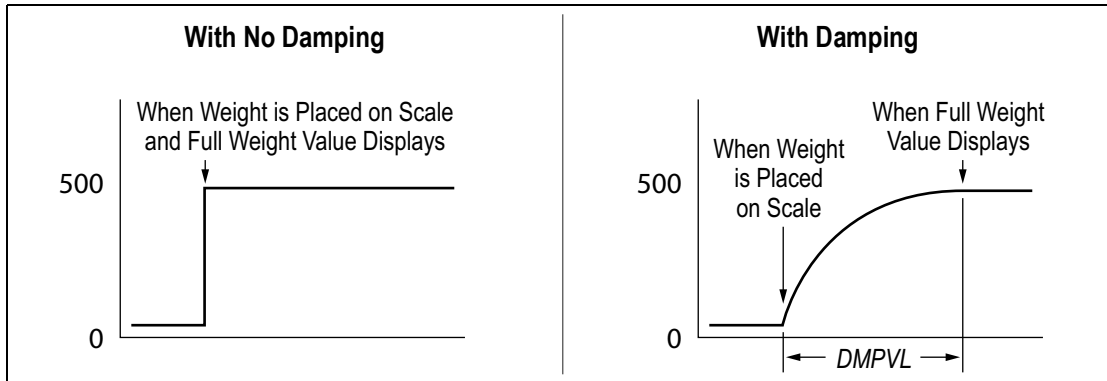

Figure 11-5. 500 lb Displayed Weight Progression

11.8 Regulatory Mode Functions

Regulatory Parameter	Weight On Scale	Tare In System	Front Panel Key Tare	Front Panel Key Zero
NTEP	Zero	No	"000000"	Zero
		Yes	Clear tare	Zero
	Negative	No	No action	Zero
		Yes	Clear tare	Zero
	Positive	No	Tare	Zero
		Yes	Tare	Zero
Canada	Zero	No	"000000"	Zero
		Yes	Clear tare	Clear tare
	Negative	No	No action	Zero
		Yes	Clear tare	Clear tare
	Positive	No	Tare	Zero
		Yes	No action	Clear tare
OIML	Zero	No	"000000"	Zero
		Yes	Clear tare	Zero and Clear tare
	Negative	No	No action	Zero
		Yes	Clear tare	Zero and Clear tare
	Positive	No	"000000"	Zero
		Yes	Tare	Zero and Clear Tare
None	Zero	No	"000000"	Zero
		Yes	Clear tare	Clear tare
	Negative	No	No action	Zero
		Yes	Clear tare	Clear tare
	Positive	No	Tare	Zero
		Yes	Clear tare	Clear tare

Table 11-4. Tare and Zero Key Functions for REGULA Parameter Settings

11.9 ASCII Character Chart

Use the decimal values for ASCII characters listed in [Table 11-5](#) when specifying print format strings on the 680HE PFORMT menu ([Section 4.4.6 on page 33](#)). The actual character printed depends on the character mapping used by the output device.

The 680HE can send or receive ASCII character values (decimal 0–255), but the indicator display is limited to numbers, uppercase, unaccented letters and a few special characters. See [Section 11.10 on page 72](#) for information about the 680HE LED display characters.

Control	ASCII	Dec	Hex	ASCII	Dec	Hex	ASCII	Dec	Hex	ASCII	Dec	Hex
Ctrl-@	NUL	00	00	space	32	20	@	64	40	`	96	60
Ctrl-A	SOH	01	01	!	33	21	A	65	41	a	97	61
Ctrl-B	STX	02	02	"	34	22	B	66	42	b	98	62
Ctrl-C	ETX	03	03	#	35	23	C	67	43	c	99	63
Ctrl-D	EOT	04	04	\$	36	24	D	68	44	d	100	64
Ctrl-E	ENQ	05	05	%	37	25	E	69	45	e	101	65
Ctrl-F	ACK	06	06	&	38	26	F	70	46	f	102	66
Ctrl-G	BEL	07	07	'	39	27	G	71	47	g	103	67
Ctrl-H	BS	08	08	(40	28	H	72	48	h	104	68
Ctrl-I	HT	09	09)	41	29	I	73	49	i	105	69
Ctrl-J	LF	10	0A	*	42	2A	J	74	4A	j	106	6A
Ctrl-K	VT	11	0B	+	43	2B	K	75	4B	k	107	6B
Ctrl-L	FF	12	0C	,	44	2C	L	76	4C	l	108	6C
Ctrl-M	CR	13	0D	-	45	2D	M	77	4D	m	109	6D
Ctrl-N	SO	14	0E	.	46	2E	N	78	4E	n	110	6E
Ctrl-O	SI	15	0F	/	47	2F	O	79	4F	o	111	6F
Ctrl-P	DLE	16	10	0	48	30	P	80	50	p	112	70
Ctrl-Q	DC1	17	11	1	49	31	Q	81	51	q	113	71
Ctrl-R	DC2	18	12	2	50	32	R	82	52	r	114	72
Ctrl-S	DC3	19	13	3	51	33	S	83	53	s	115	73
Ctrl-T	DC4	20	14	4	52	34	T	84	54	t	116	74
Ctrl-U	NAK	21	15	5	53	35	U	85	55	u	117	75
Ctrl-V	SYN	22	16	6	54	36	V	86	56	v	118	76
Ctrl-W	ETB	23	17	7	55	37	W	87	57	w	119	77
Ctrl-X	CAN	24	18	8	56	38	X	88	58	x	120	78
Ctrl-Y	EM	25	19	9	57	39	Y	89	59	y	121	79
Ctrl-Z	SUB	26	1A	:	58	3A	Z	90	5A	z	122	7A
Ctrl-[ESC	27	1B	;	59	3B	[91	5B	{	123	7B
Ctrl-\	FS	28	1C	<	60	3C	\	92	5C		124	7C
Ctrl-]	GS	29	1D	=	61	3D]	93	5D	}	125	7D
Ctrl-^	RS	30	1E	>	62	3E	^	94	5E	~	126	7E
Ctrl-_	US	31	1F	?	63	3F	_	95	5F	DEL	127	7F

Table 11-5. ASCII Character Chart



11.10 Front Panel Display Characters

Refer to [Figure 11-6](#) for the seven-segment LED character set used on the front panel display for alphanumeric characters.

!		7		Ff		Ss	
"		8		Gg		Tt	
+		9		Hh		Uu	
-		:		li		Vv	
.		;		Jj		Ww	
/		<		Kk		Xx	
0		=		Ll		Yy	
1		>		Mm		Zz	
2		Aa		Nn		[
3		Bb		Oo		\	
4		Cc		Pp]	
5		Dd		Qq		_	
6		Ee		Rr			

Figure 11-6. 680HE Display Characters

12.0 Compliance

	EU DECLARATION OF CONFORMITY <small>EU-KONFORMITÄTSERKLÄRUNG DÉCLARATION UE DE CONFORMITÉ</small>		Rice Lake Weighing Systems 230 West Coleman Street Rice Lake, Wisconsin 54868 United States of America 
	Type/Typ/Type: 680, 680HE and 682 indicator series		
English	We declare under our sole responsibility that the products to which this declaration refers to, is in conformity with the following standard(s) or other regulations document(s).		
Deutsch	Wir erklären unter unserer alleinigen Verantwortung, dass die Produkte auf die sich diese Erklärung bezieht, den folgenden Normen und Regularungsbestimmungen entsprechen.		
Francais	Nous déclarons sous notre responsabilité que les produits auxquels se rapporte la présente déclaration, sont conformes à la/aux norme/s suivante ou au/aux document/s normatif/s suivant/s.		
EU Directive	Certificates	Standards Used / Notified Body Involvement	
22014/35/EU LVD	-	680: IEC 61010-1:2010+A1:2016 682, 680HE: EN 62368-1:2014 + A11:2017	
2014/30/EU EMC	-	EN 61326-1:2013, EN 61000-3-3:2013, EN 61000-6-2, EN 61000-6-4, EN55011:2009/A1:2010	
2014/53/EU RED	-	EN 301 489-17 V3.2.4, EN 300 328 V2.2.2, EN 301 893 V2.1.1	
2011/65/EU RoHS	-	EN 50581:2012	
Signature:	<u>Brandi Harder</u>		Place: <u>Rice Lake, WI USA</u>
Name:	<u>Brandi Harder</u>		Date: <u>March 30, 2022</u>
Title:	<u>Quality Manager</u>		



**UK DECLARATION
OF CONFORMITY**

Rice Lake Weighing Systems
230 West Coleman Street
Rice Lake, Wisconsin 54868
United States of America



Type: 680, 680HE and 682 indicator series

English We declare under our sole responsibility that the products to which this declaration refers to, is in conformity with the following standard(s) or other regulations document(s).

UK Regulations	Certificates	Standards Used / Approved Body Involvement
2016/1101 Low Voltage	-	680: IEC 61010-1:2010+A1:2016 682, 680HE: EN 62368-1:2014 + A11:2017
2016/1091 EMC	-	EN 61326-1:2013, EN 61000-3-3:2013, EN 61000-6-2, EN 61000-6-4, EN55011:2009/A1:2010
2017/1206 Radio	-	EN 301 489-17 V3.2.4, EN 300 328 V2.2.2, EN 301 893 V2.1.1
2012/3032 RoHS	-	EN 50581:2012

Signature: Brandi Harder

Place: Rice Lake, WI USA

Name: Brandi Harder

Date: March 30, 2022

Title: Quality manager

13.0 Specifications

Power

Line voltage: 100–240 VAC
Frequency: 50–60 Hz

Power Consumption:

12 W (AC) with one 350 Ω load cell, 30 W max

Excitation Voltage

10 VDC bi-polar (± 5 VDC)

Analog Output (Optional)

Type: Voltage or current output, 16-bit resolution
Voltage output: 0–10 VDC
Voltage load resistance: 1 K Ω minimum
Current output: 0–20 mA, 4–20 mA
Current loop resistance: 1 K Ω maximum

Analog Signal Input Range

-5 mV to +70 mV

Analog Signal Sensitivity

Recommended: 1 μ V/graduation

A/D Sample Rate

6.25–120 Hz, software selectable

Resolution

Internal: 8,000,000 counts
Display: 100,000

System Linearity / PI Rating

Within 0.01% full scale

Digital I/O

Four configurable I/O (5 V logic)

Communication Ports

Two RS-232 (three-wire)
RS-485/422 (two-wire or four-wire)
Micro USB (device)
Ethernet (10/100)

Status Annunciators

Eight LED annunciators

Display

Six 2.5" (63.5 mm) tall, seven-segment digits

Keys / Buttons

Flat membrane panel, tactile feel (18 buttons)

Temperature Range

Legal: 14–104°F (-10–40°C)
Industrial: 14–122°F (-10–50°C)

EMC Immunity

10 V/m

Dimensions (W x H x D)

Overall 14.0 x 11.8 x 6.5 in (355.6 x 299.7 x 165.1 mm)
Enclosure 12.5 x 10.5 x 6.3 in (317.5 x 266.7 x 160.0 mm)

Weight

7.5 lb (3.4 kg)

Rating / Material

Rating: IP66
Material: FRP

Warranty

Two-year limited warranty

Certifications and Approvals



NTEP

CoC Number 19-021
Accuracy Class: III/IIIL; n_{max} : 10000



Measurement Canada

File Number: AM6121
Accuracy Class: III/IIILD; n_{max} : 10000



UL Listed





© Rice Lake Weighing Systems Specifications subject to change without notice.

230 W. Coleman St. • Rice Lake, WI 54868 • USA

U.S. 800-472-6703 • Canada/Mexico 800-321-6703 • International 715-234-9171 • Europe +31 (0)26 472 1319